

**U-Handles**  
24300.0540



**Product Description**

U-handles are used, for example, on machine doors, furniture doors, cabinet doors, drawers and drawer units.

These U-handles are characterised by their ergonomic profile design with very high stability and their simple and timeless design.

**Material**

**Handle**

- Stainless steel 1.4301, dull blasted

**Assembly**

Back mount handle.

**Drawing**

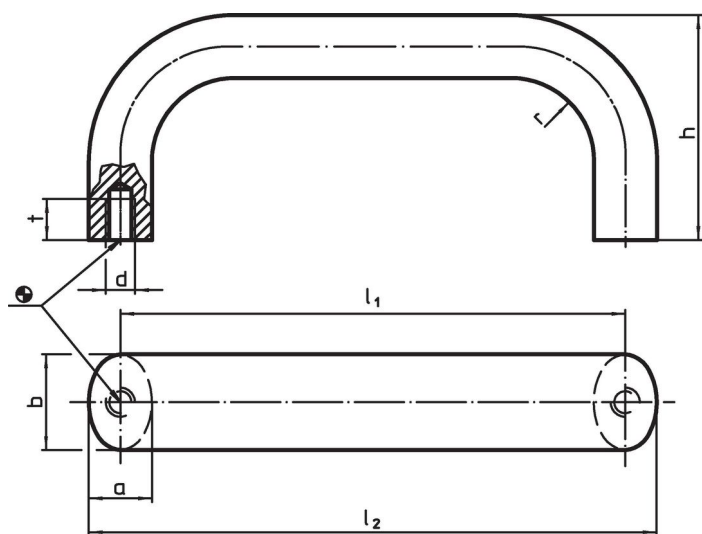

**Order information**

b	l <sub>1</sub> ±0.25	l <sub>2</sub>	Dimensions					[g]	Art. No.
			a	d	h	r	t		
[mm]									
stainless steel, dull blasted, Stainless steel									
20	200	213	13	M6	51	13	10	440	24300.0540

**Application example**

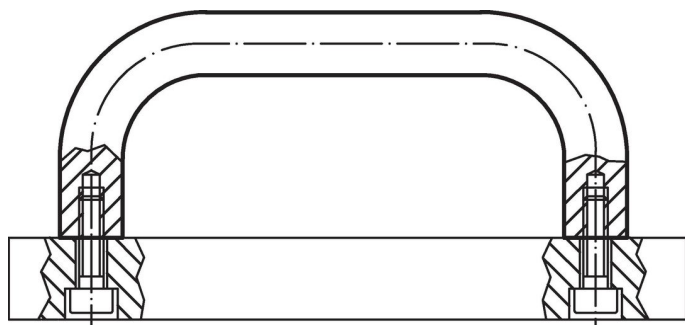

## Compliance

### RoHS compliant

Compliant according to Directive 2011/65/EU and Directive 2015/863.

### Does not contain SVHC substances

No SVHC substances with more than 0.1% w/w contained - SVHC list [REACH] as of 23.01.2024.

### Does not contain Proposition 65 substances

No Proposition 65 substances included.

<https://www.P65Warnings.ca.gov/>

### Free from Conflict Minerals

This product does not contain any substances designated as "conflict minerals" such as tantalum, tin, gold or tungsten from the Democratic Republic of Congo or adjacent countries.