

Fulcrum Pins

23400.0102



Product Description

Material

Fulcrum Pin

- Stainless steel 1.4021, heat-treated

Safety ring

- Stainless steel 1.4310

More information

References

Suitable for eccentric levers EH 23390. and similar applications.

Drawing

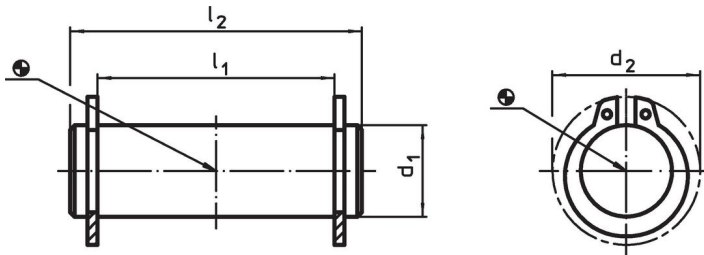

Order information

Dimensions					[g]	Art. No.
d_1	l_1	d_2	l_2	[mm]		
f8	-0.5					
10	18	17	24		19	23400.0102

Application example

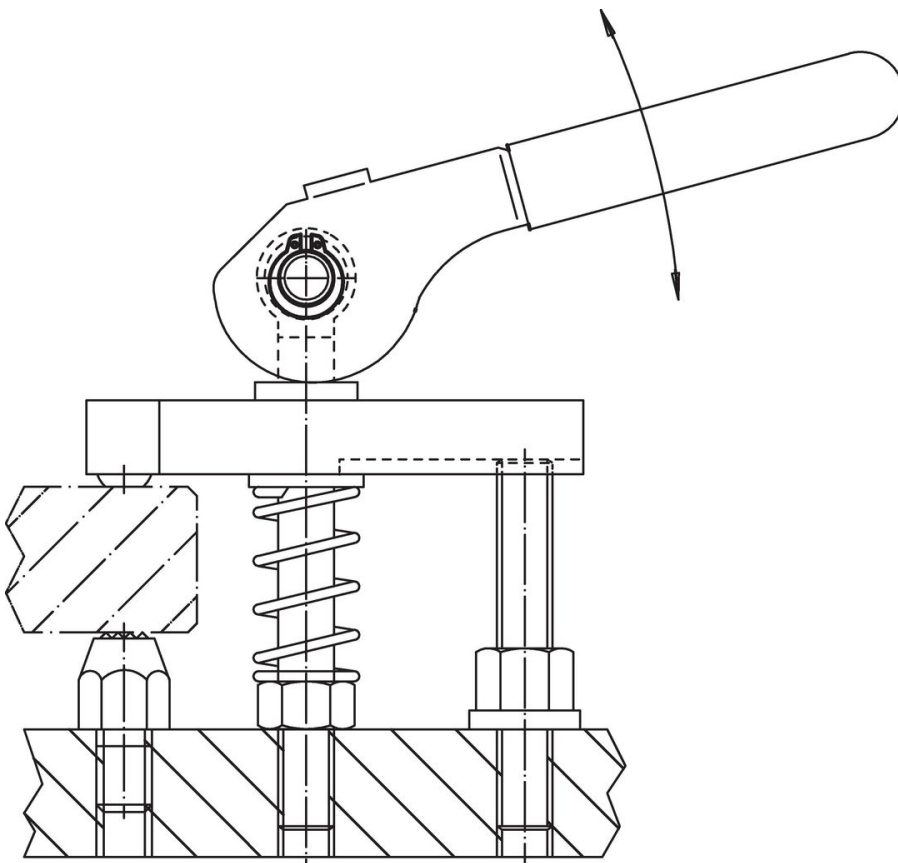

Compliance

RoHS compliant

Compliant according to Directive 2011/65/EU and Directive 2015/863.

Does not contain SVHC substances

No SVHC substances with more than 0.1% w/w contained - SVHC list [REACH] as of 23.01.2024.

Does not contain Proposition 65 substances

No Proposition 65 substances included.

<https://www.P65Warnings.ca.gov/>

Free from Conflict Minerals

This product does not contain any substances designated as "conflict minerals" such as tantalum, tin, gold or tungsten from the Democratic Republic of Congo or adjacent countries.