

## Eccentric Quick Clamps · with screw

23390.0035



### Product Description

For quick and easy clamping and releasing of workpieces.  
When using the "adjustable" design (picture 2) the lever position can be moved.

### Material

#### Support washer

- Thermoplastic PA, glass-fiber reinforced

#### Lever

- Zinc die-cast, plastic coated, black, similar to RAL 9005

#### Inner parts

- Steel, zinc-plated by galvanization

#### Screw

- Steel, zinc-plated by galvanization

#### Adjusting nut

- Steel, zinc-plated by galvanization

### Drawing

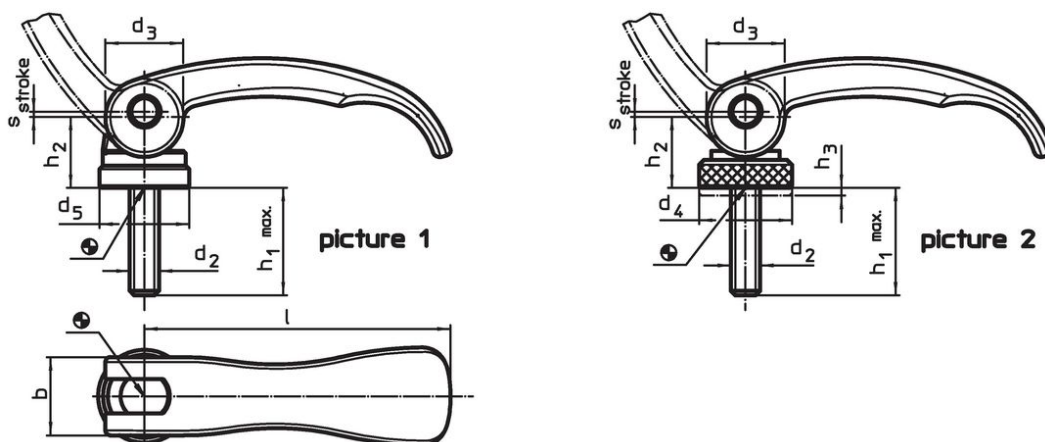

### Order information

Dimensions							Stroke s at 90° lever position	🌡️ max.	📦 [g]	Art. No.
l	d <sub>2</sub>	h <sub>1</sub> max. in clamping position	d <sub>3</sub>	d <sub>5</sub>	h <sub>2</sub> max.	b				
[mm]							[mm]	[°C]	[g]	
with screw – picture 1, Steel										
63	M5	40	16	18.5	16.4	16	0.75	80	65	23390.0035

## Application example



## Compliance

### RoHS compliant

Compliant according to Directive 2011/65/EU and Directive 2015/863.

### Does not contain SVHC substances

No SVHC substances with more than 0.1% w/w contained - SVHC list [REACH] as of 27.06.2024.

### Does not contain Proposition 65 substances

No Proposition 65 substances included.

<https://www.P65Warnings.ca.gov/>

### Free from Conflict Minerals

This product does not contain any substances designated as "conflict minerals" such as tantalum, tin, gold or tungsten from the Democratic Republic of Congo or adjacent countries.