

Centering Clamping Elements • with clamping balls

23340.0230



Product Description

To be used for accurate centering and clamping of workpieces with locating hole on which light spherical marks are acceptable. Exact self-centering with a precision of $\pm 0,025$ mm. The clamping balls frictionally center and hold workpieces with raw or pre-machined surfaces down to the bearing points. Large adjustment stroke and a small building height are a feature of this center clamping element.

Mounting from either top or bottom.

Material

Body

- Tool steel, hardened, blackened

Spring

- Stainless steel

Clamping balls

- Stainless steel 1.4112, hardened and ground

Assembly

Assembly instruction for mounting from above: Remove clamping plate and screw. Screw in threaded pin from below, and tighten from above using female WS₂.

Further or detailed information can be found in the assembly and operating instructions.

More information

Further products

- Centering Clamping Elements, with clamping segments
- Centering Clamping Elements, with clamping segments, operation from the bottom
- Centering Clamping Elements, with clamping balls, operation from the bottom

Drawing

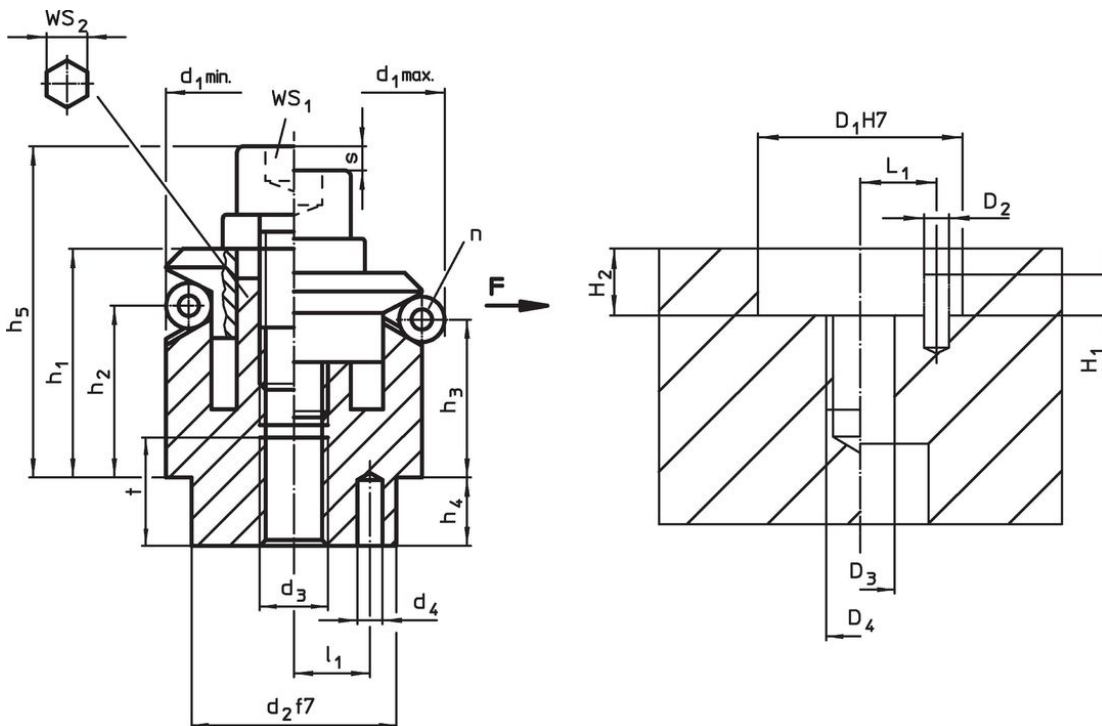

Order information

Dimensions													Number	Stroke	WS		Clamping	Tightening	Location hole				Art. No.				
d ₁ min.	d ₁ max.	d ₂ f7	d ₃	d ₄ +0.3	h ₁ -1	h ₂	h ₃	h ₄	h ₅ -2	l ₁ ±0.1	Ball diameter	t	of balls n	s	WS ₁	WS ₂	force F max.	torque max.	D ₁ H7	D ₂	D ₃	D ₄		H ₁	H ₂	L ₁	[g]
[mm]														[mm]	[mm]	[mm]	[kN]	[Nm]	[mm]								
30.5	38.5	25	M6	4	23.2	14.1	11.8	7	32.2	9	8	8	3	4.6	5	6	5	17	25	4	6	M6	3.5	7	9	119	23340.0230

Application example

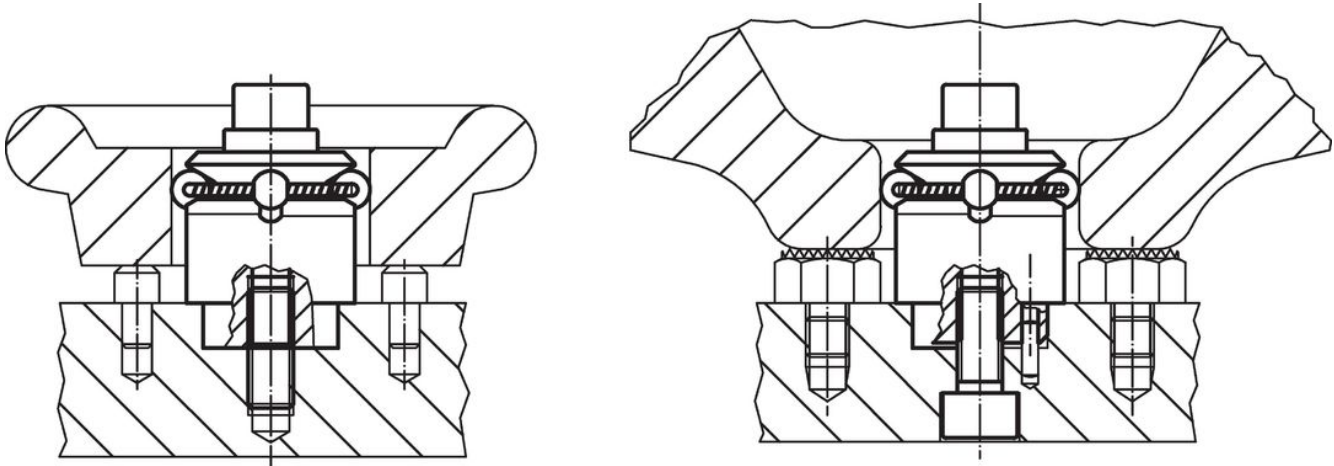

Compliance

RoHS compliant

Compliant according to Directive 2011/65/EU and Directive 2015/863.

Does not contain SVHC substances

No SVHC substances with more than 0.1% w/w contained - SVHC list [REACH] as of 23.01.2024.

Does not contain Proposition 65 substances

No Proposition 65 substances included.

<https://www.P65Warnings.ca.gov/>

Free from Conflict Minerals

This product does not contain any substances designated as "conflict minerals" such as tantalum, tin, gold or tungsten from the Democratic Republic of Congo or adjacent countries.