

## Centering Clamping Elements · with clamping segments

23340.0026



### Product Description

For clamping and centering of workpieces with internal bore. Exact self centering with a precision of  $\pm 0,025$  mm. Due to the clamping segments being ground, workpieces with raw and/or machined surfaces can be frictionally connected, centered and held down at the seats. Large adjustment stroke and a low building height are a feature of the centering clamping element. **Mounting from either top or bottom.**

### Material

#### Body

- Tool steel, hardened, blackened

#### Spring

- Stainless steel

#### Clamping segments

- Stainless steel 1.4112, hardened and ground

### Assembly

Assembly instruction for mounting from above: Remove clamping plate and screw. Screw in threaded pin from below, and tighten from above using female WS<sub>2</sub>.

Further or detailed information can be found in the assembly and operating instructions.

### More information

### Further products

- Centering Clamping Elements, with clamping balls
- Centering Clamping Elements, with clamping segments, operation from the bottom
- Centering Clamping Elements, with clamping balls, operation from the bottom

### Drawing

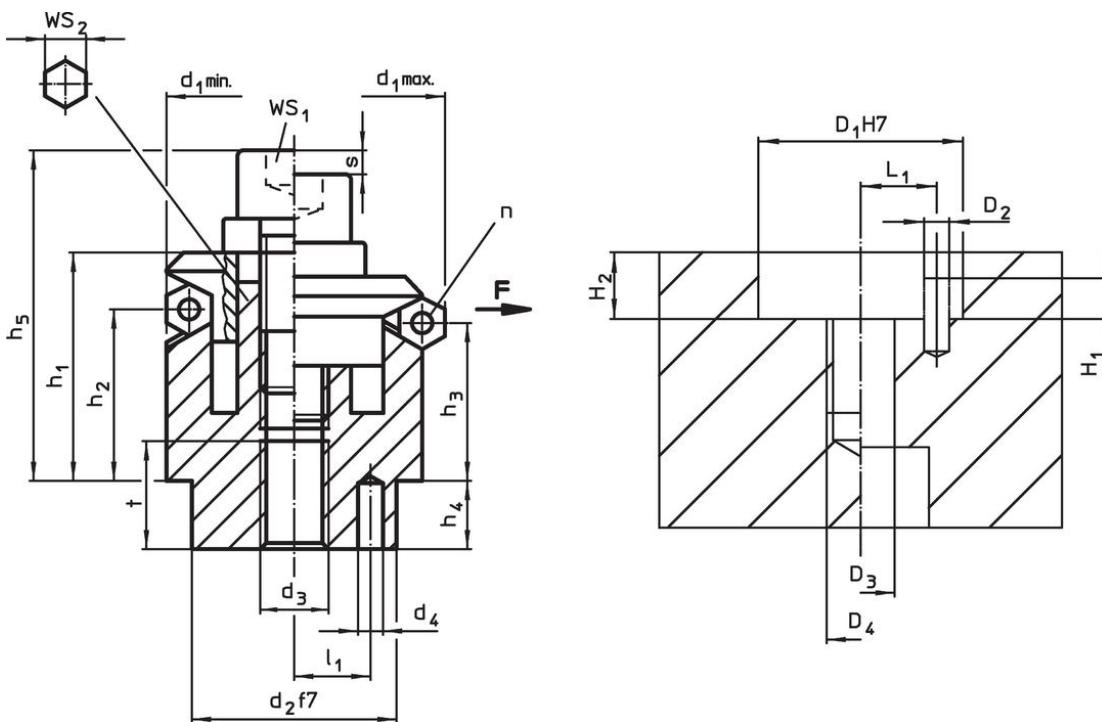

### Order information

Dimensions													Number of segments n	Stroke s [mm]	WS		Clamping force F max. [kN]	Tightening torque max. [Nm]	Location hole							Art. No.
d <sub>1</sub> min.	d <sub>1</sub> max.	d <sub>2</sub> f7	d <sub>3</sub>	d <sub>4</sub> +0.3 -1	h <sub>1</sub>	h <sub>2</sub>	h <sub>3</sub>	h <sub>4</sub>	h <sub>5</sub> -2	l <sub>1</sub> ±0.1	t	WS <sub>1</sub>			WS <sub>2</sub>	D <sub>1</sub> H7			D <sub>2</sub>	D <sub>3</sub>	D <sub>4</sub>	H <sub>1</sub>	H <sub>2</sub>	L <sub>1</sub>	[g]	
[mm]															[mm]	[mm]	[kN]	[Nm]	[mm]							
26.5	30.5	20	M6	3	19.9	14.2	13	6	28.9	7	8	3	2.3	5	6	5	17	20	3	6	M6	3	6	7	96	23340.0026

### Application example

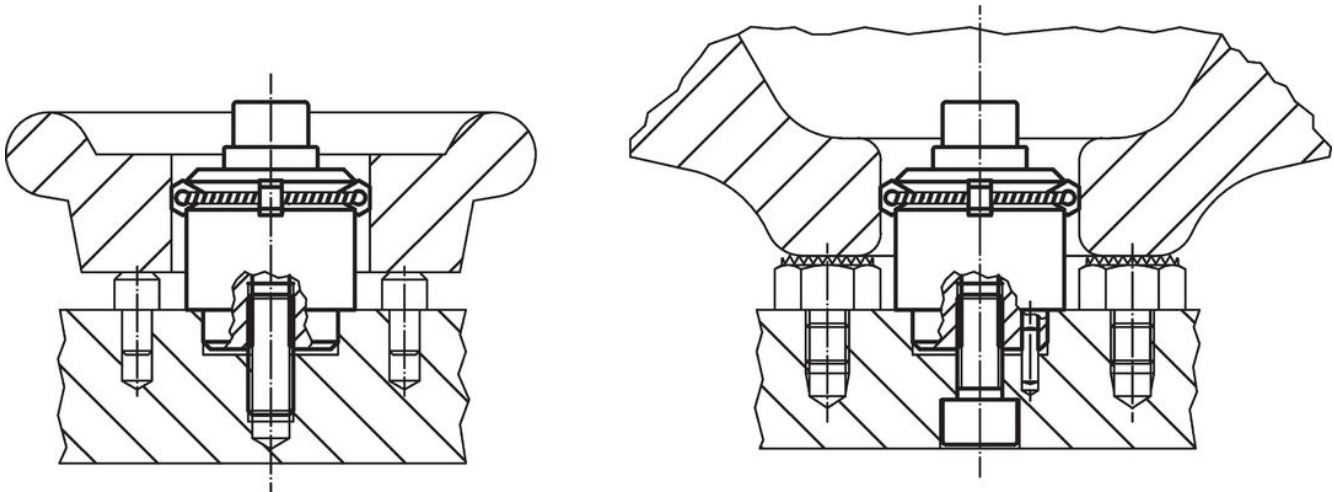

### Compliance

#### RoHS compliant

Compliant according to Directive 2011/65/EU and Directive 2015/863.

#### Does not contain SVHC substances

No SVHC substances with more than 0.1% w/w contained - SVHC list [REACH] as of 23.01.2024.

#### Does not contain Proposition 65 substances

No Proposition 65 substances included.

<https://www.P65Warnings.ca.gov/>

#### Free from Conflict Minerals

This product does not contain any substances designated as "conflict minerals" such as tantalum, tin, gold or tungsten from the Democratic Republic of Congo or adjacent countries.