

Toggle Clamps Push-Pull Type · with fastening thread

23330.2104



Product Description

Due to their favourable power to movement ratio and their easy action the toggle clamps are versatile applicable for a wide range of uses.

These toggle clamps can be used in the metal working industry when drilling, welding, bending, grinding, testing and fitting as well as in the wood and plastic industry in glueing, drilling, cutting and milling jigs.

The "toggle" principle of the toggle clamp allows a large and quick opening of the clamp. If unclamped the workpieces are completely cleared for unimpeded removal. The large power transmission results maximum clamping force by low hand force. The clamps are self-arresting they remain locked, resisting the force produced when machining components.

The toggle clamps are manufactured from high quality components and are designed for maintenance-free continuous use.

An oil resistant ergonomic 2-component handle, with slip-proof, soft surface and large grip area for high ease of use.

Material

Clamp

- Steel, zinc-plated by galvanization, passivated

Rivet

- Stainless steel

Handle

- plastic

Clamping screw

- Steel, tempered, zinc-plated by galvanization

Clamping cap

- Rubber, black

More information

References

Replacement clamping screws are available as accessories in the online shop.

Drawing

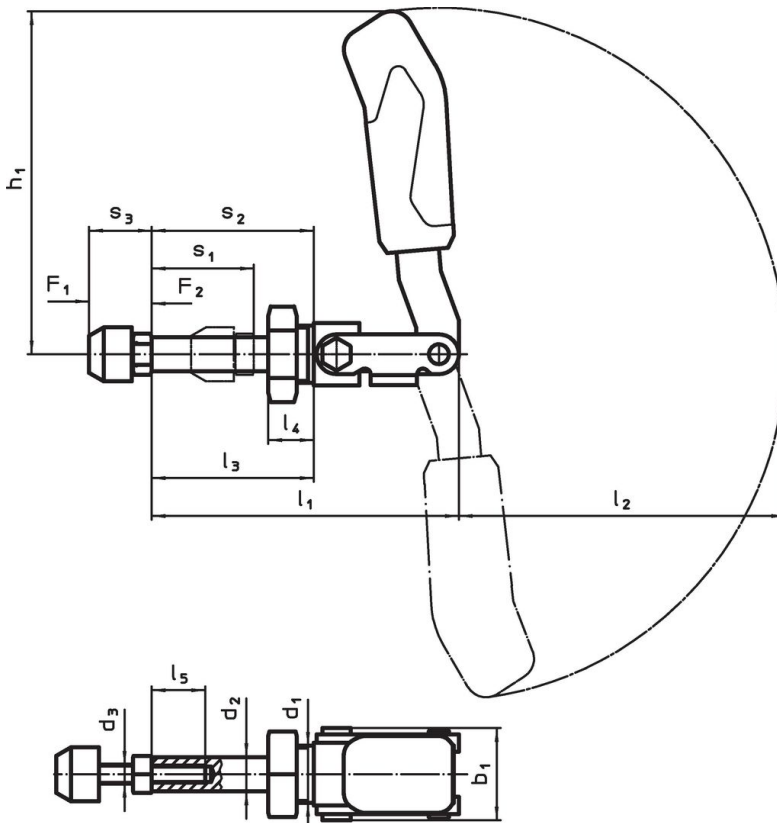

Order information

Nominal size	Clamping screw [mm]	Dimensions													Stroke s ₁ [mm]	Holding force		Temperature		Weight [g]	Art. No.
		d ₁	d ₂	d ₃	b ₁	h ₁	l ₁	l ₂	l ₃	l ₄	l ₅	s ₂	s ₃ min.	s ₃ max.		F ₁ [kN]	F ₂ [kN]	min. [°C]	max. [°C]		
4	M8 x 35	M20 x 1,5	12	M8	33	123	108	115	57	16	25	57	22	35	40	2.5	2.5	-10	80	327	23330.2104

Accessories

	d ₂ [mm]	Weight [g]	Art. No.
Clamping screw (spare part of toggle clamps push-pull type)			
 No Photo available	M 8 x 35	25	23330.9014

Application example

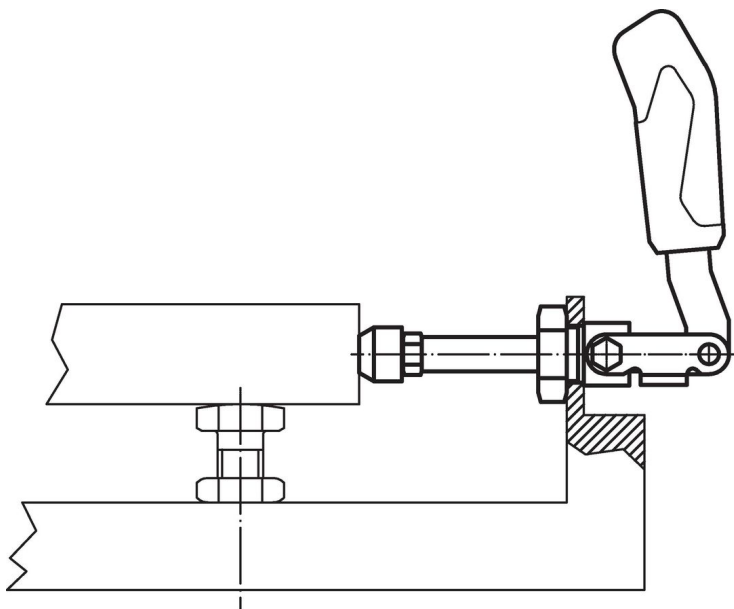

Compliance

RoHS compliant

Compliant according to Directive 2011/65/EU and Directive 2015/863.

Does not contain SVHC substances

No SVHC substances with more than 0.1% w/w contained - SVHC list [REACH] as of 23.01.2024.

Does not contain Proposition 65 substances

No Proposition 65 substances included.

<https://www.P65Warnings.ca.gov/>

Free from Conflict Minerals

This product does not contain any substances designated as "conflict minerals" such as tantalum, tin, gold or tungsten from the Democratic Republic of Congo or adjacent countries.