

Vertical Toggle Clamps · with vertical base

23330.0017

**Product Description**

Due to their favourable power to movement ratio and their easy action the toggle clamps are versatile applicable for a wide range of uses.

These toggle clamps can be used in the metal working industry when drilling, welding, bending, grinding, testing and fitting as well as in the wood and plastic industry in glueing, drilling, cutting and milling jigs.

The "toggle" principle of the toggle clamp allows a large and quick opening of the clamp. If unclamped the workpieces are completely cleared for unimpeded removal. The large power transmission results maximum clamping force by low hand force. The clamps are self-arresting they remain locked, resisting the force produced when machining components.

The toggle clamps are manufactured from high quality components and are designed for continuous use.

A oil resistant ergonomic 2-component handle, with increased grip area with soft surface for high ease of use.

The quickly adjustable clamping screws are provided by a retainer.

Material**Clamp**

- Steel, zinc-plated by galvanization, passivated

Rivet

- Stainless steel

Handle

- plastic

Clamping screw

- Steel, tempered, zinc-plated by galvanization

Clamping cap

- Rubber, black

More information**References**

Replacement clamping screws are available as accessories in the online shop.

Drawing

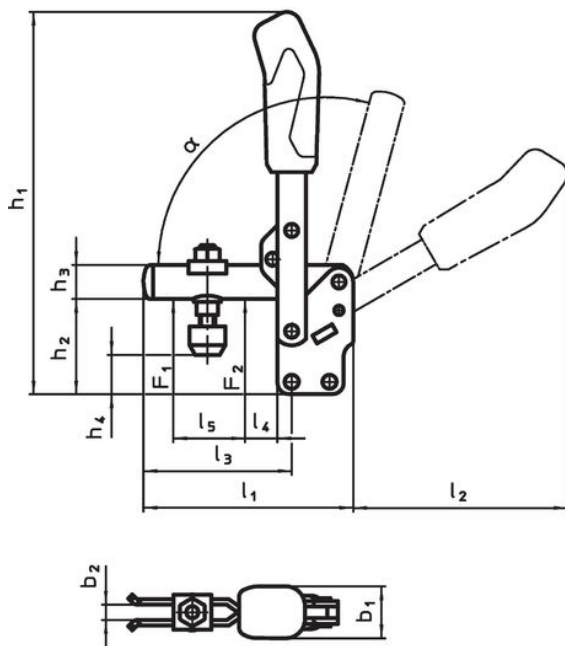

23330.0013

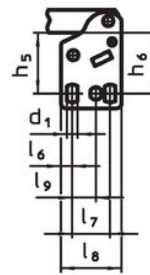

23330.0014

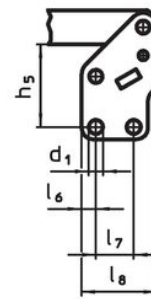

23330.0015

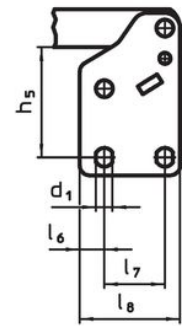

23330.0016

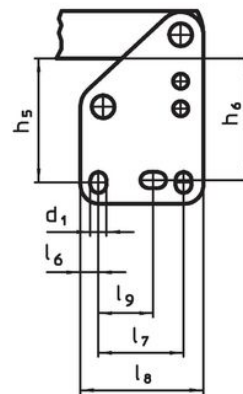

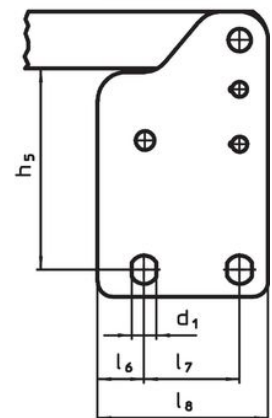

23330.0017



Order information

Nominal size	Clamping screw	Dimensions																		Holding force		α	Temperature range		Weight	Art. No.
		d_1	b_1	b_2	b_3	h_1	h_2	h_3	h_4	h_4 min. max.	h_5	l_1	l_2	l_3	l_4	l_5	l_6	l_7	l_8	F_1	F_2		min.	max.		
	[mm]	[mm]																		[kN]		[°C]				
7	M12 x 110	13	39	14	10	369	117	30	33	90.5	102	231	206	165	28	89	24.5	50.5	90	3.4	5.5	60°	-10	80	2000	23330.0017

Accessories

	d ₂ [mm]	 [g]	Art. No.
Clamping screw (spare part of toggle clamp)			
	M12 x 110	170	23330.9008

Compliance

RoHS compliant

Compliant according to Directive 2011/65/EU and Directive 2015/863.

Does not contain SVHC substances

No SVHC substances with more than 0.1% w/w contained - SVHC list [REACH] as of 23.01.2024.

Does not contain Proposition 65 substances

No Proposition 65 substances included.

<https://www.P65Warnings.ca.gov/>

Free from Conflict Minerals

This product does not contain any substances designated as "conflict minerals" such as tantalum, tin, gold or tungsten from the Democratic Republic of Congo or adjacent countries.