

## Vertical Toggle Clamps · with vertical base

23330.0015

**Product Description**

Due to their favourable power to movement ratio and their easy action the toggle clamps are versatile applicable for a wide range of uses.

These toggle clamps can be used in the metal working industry when drilling, welding, bending, grinding, testing and fitting as well as in the wood and plastic industry in glueing, drilling, cutting and milling jigs.

The "toggle" principle of the toggle clamp allows a large and quick opening of the clamp. If unclamped the workpieces are completely cleared for unimpeded removal. The large power transmission results maximum clamping force by low hand force. The clamps are self-arresting they remain locked, resisting the force produced when machining components.

The toggle clamps are manufactured from high quality components and are designed for continuous use.

A oil resistant ergonomic 2-component handle, with increased grip area with soft surface for high ease of use.

The quickly adjustable clamping screws are provided by a retainer.

**Material****Clamp**

- Steel, zinc-plated by galvanization, passivated

**Rivet**

- Stainless steel

**Handle**

- plastic

**Clamping screw**

- Steel, tempered, zinc-plated by galvanization

**Clamping cap**

- Rubber, black

**More information****References**

Replacement clamping screws are available as accessories in the online shop.

Drawing

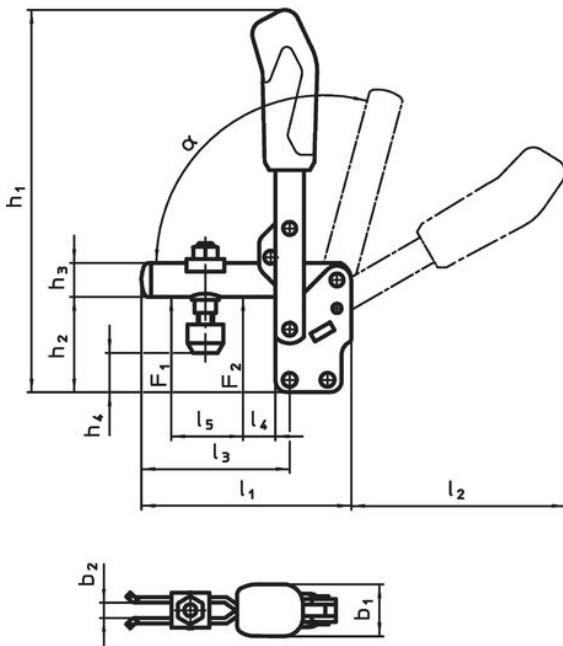

23330.0013

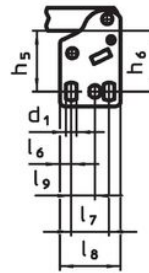

23330.0014

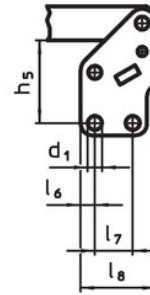

23330.0015

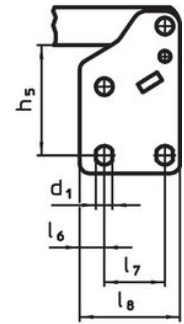

23330.0016

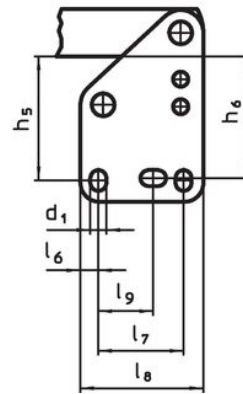

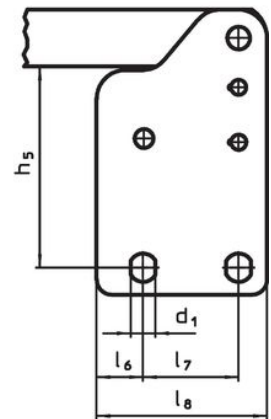

23330.0017



Order information

Nominal size	Clamping screw [mm]	Dimensions																		Holding force		$\alpha$	Temperature		Weight [g]	Art. No.
		d <sub>1</sub>	b <sub>1</sub>	b <sub>2</sub>	b <sub>3</sub>	h <sub>1</sub>	h <sub>2</sub>	h <sub>3</sub>	h <sub>4</sub> min.	h <sub>4</sub> max.	h <sub>5</sub>	l <sub>1</sub>	l <sub>2</sub>	l <sub>3</sub>	l <sub>4</sub>	l <sub>5</sub>	l <sub>6</sub>	l <sub>7</sub>	l <sub>8</sub>	l <sub>9</sub>	F <sub>1</sub>		F <sub>2</sub>	min.		
5	M8 x 65	8.6	35	10	8	244	65	20	16.5	45.5	55.5	141	130	101	16	54	13	32	53	1.7	3	60°	-10	80	689	23330.0015

Accessories

	d <sub>2</sub> [mm]	 [g]	Art. No.
<b>Clamping screw (spare part of toggle clamp)</b>			
	M 8 x 65	57	23330.9006

Compliance

**RoHS compliant**

Compliant according to Directive 2011/65/EU and Directive 2015/863.

**Does not contain SVHC substances**

No SVHC substances with more than 0.1% w/w contained - SVHC list [REACH] as of 23.01.2024.

**Does not contain Proposition 65 substances**

No Proposition 65 substances included.  
<https://www.P65Warnings.ca.gov/>

**Free from Conflict Minerals**

This product does not contain any substances designated as "conflict minerals" such as tantalum, tin, gold or tungsten from the Democratic Republic of Congo or adjacent countries.