

Down-Thrust Clamps • swivelling, size 60

23310.0067

**Product Description**

Universal mechanical clamping element for fast and comfortable changing and clamping of workpieces by means of manually swivelling clamping claw.

The clamps have the following advantages:

- Rapid manual clamping by means of clamping screw.
- Easy and rapid changing of workpieces by swinging away the clamping claw to the left or right. The positioning ring 23310.0360 allows infinitely variable adjustment.
- The use of positioning ring 23310.0360 allows a repeatable precise clamping. Here h_1 min. increases by at least 10 mm (stroke minus 10 mm).
- Compact design, thus little space taken-up for clamping.
- Easy adjustment even to large clamping heights due to the height adjusting cylinders.

Material**Clamp**

- Case-hardened steel, case-hardened, blackened and ground

Assembly

Down-thrust clamps can be attached in two ways:

1. in a T-slot, using a nut for T-slots DIN 508 (EH 23010.)
2. with the set screw directly in the mounting plate of, for example, a fixture

The cylinder must make contact over the whole surface.

More information**References**

The clamping height can be increased with height adjusting cylinders EH 23310. and with spacers EH 1617. and reduced with clamping inserts.

Further products

- Positioning Rings, for down-thrust clamp
- Wrenches
- Spacers

Drawing

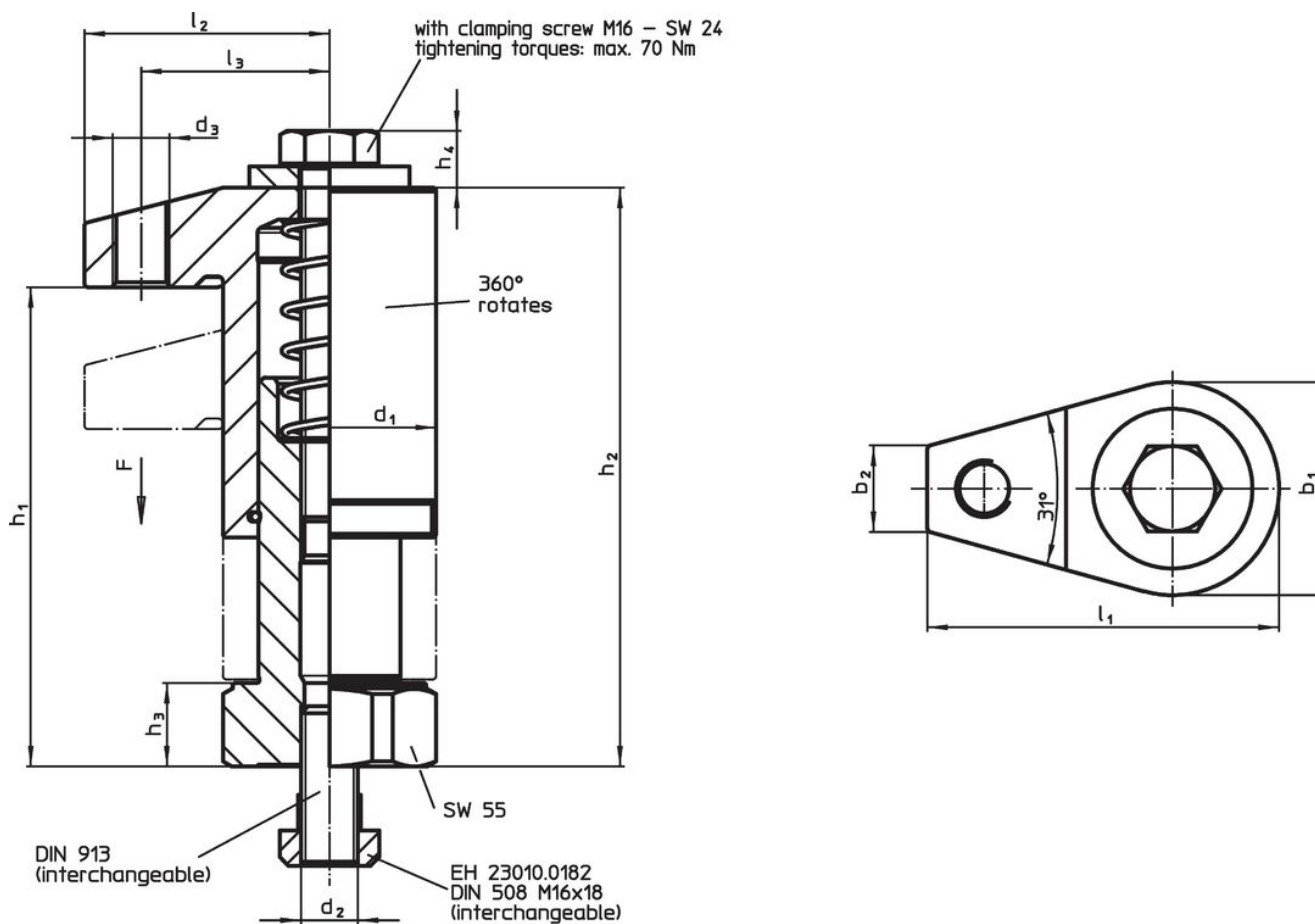

Order information

Dimensions										Stroke	Clamping force	Tightening torque max.		Art. No.
d ₁	b ₁	b ₂	d ₃	h ₁	h ₂	h ₃	l ₁	l ₂	l ₃					
with clamping screw														
60	60	24	M16	95 – 135	123 – 163	24	99	69	53	40	15	70	3020	23310.0067

Application example

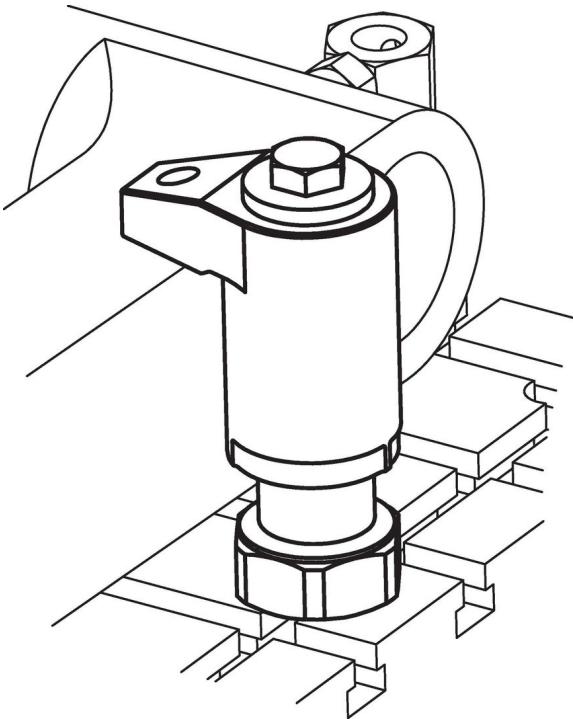

Compliance

RoHS compliant

Contains lead - compliant according to exceptions 6a / 6b / 6c.

Contains SVHC substances >0,1% w/w

Contains lead - SVHC list [REACH] as of 27.06.2024.

Contains Proposition 65 substances



Lead can cause cancer and reproductive harm from exposure
<https://www.P65Warnings.ca.gov/>

Free from Conflict Minerals

This product does not contain any substances designated as "conflict minerals" such as tantalum, tin, gold or tungsten from the Democratic Republic of Congo or adjacent countries.