

Down-Thrust Clamps • swivelling, size 60

23310.0063

**Product Description**

Universal mechanical clamping element for fast and comfortable changing and clamping of workpieces by means of manually swivelling clamping claw.

The clamps have the following advantages:

- Rapid manual clamping by means of clamping screw or double eccentric lever.
- Easy and rapid changing of workpieces by swinging away the clamping claw to the left or right.
- Compact design, thus only a small amount of space is required for clamping.
- Easy adjustment even to large clamping heights due to the height adjusting cylinders.

As the force applied by the operator is not known for the versions with levers, the clamping force is given in the tables as a guide value. The average value was determined by tests.

Material

- Case-hardened steel, case-hardened, blackened and ground

Assembly

Down-thrust clamps can be attached in two ways:

1. in a T-slot, using a nut for T-slots DIN 508 (EH 23010.)
2. with the set screw directly in the mounting plate of, for example, a fixture

The cylinder must make contact over the whole surface.

The clamping height h_1 must not be exceeded.

More information**Notes**

This is a discontinued model. The successor model is available as a version with clamping screw (art. no. 23310.0065 and 23310.0067).

References

The clamping height can be increased by using height adjusting cylinders EH 23310. and disks EH 1107., EH 1108. and EH 1617. It can be reduced by using clamping inserts.

Further products

- Height Adjusting Cylinders
- Spacers
- Wrenches
- Spacers

Drawing

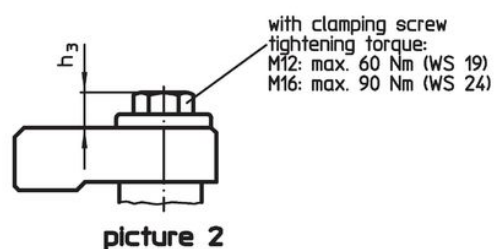
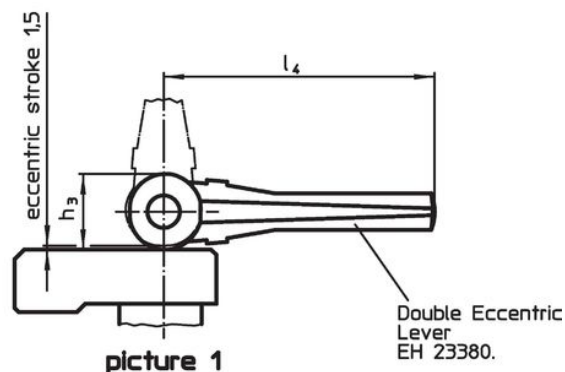
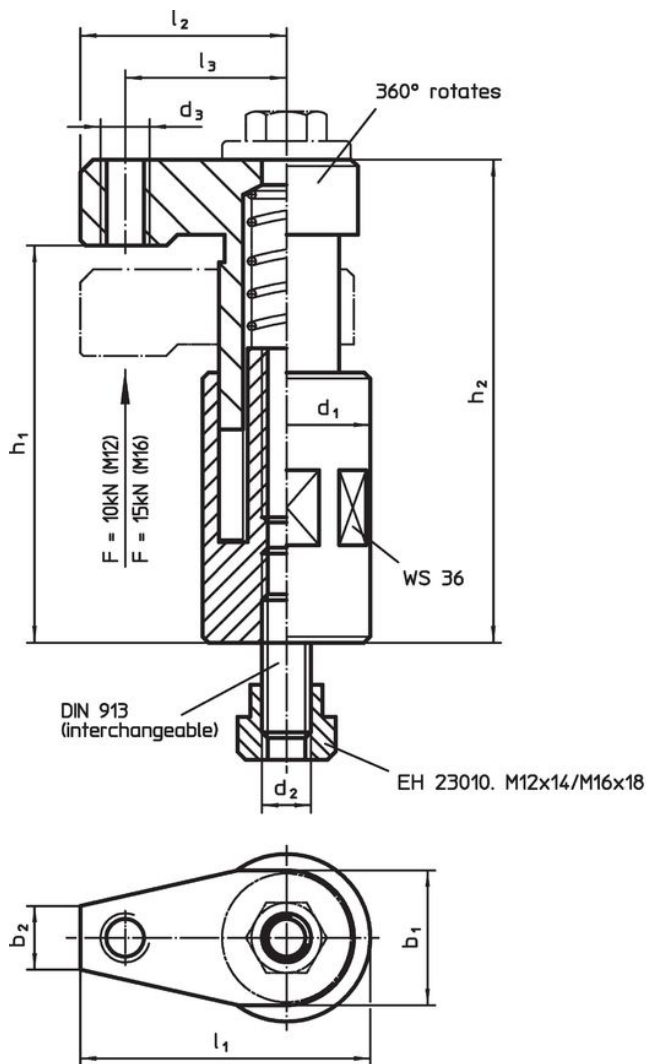

Order information

Dimensions											Stroke	Clamping force	Tightening torque max.	g	Art. No.
d ₁	d ₂	b ₁	b ₂	d ₃	h ₁	h ₂	h ₃	l ₁	l ₂	l ₃					
with clamping screw – picture 2															
60	M16	53	24	M16	100 – 135	123 – 158	16	99	69	53	35	15	90	2939	23310.0063

Application example

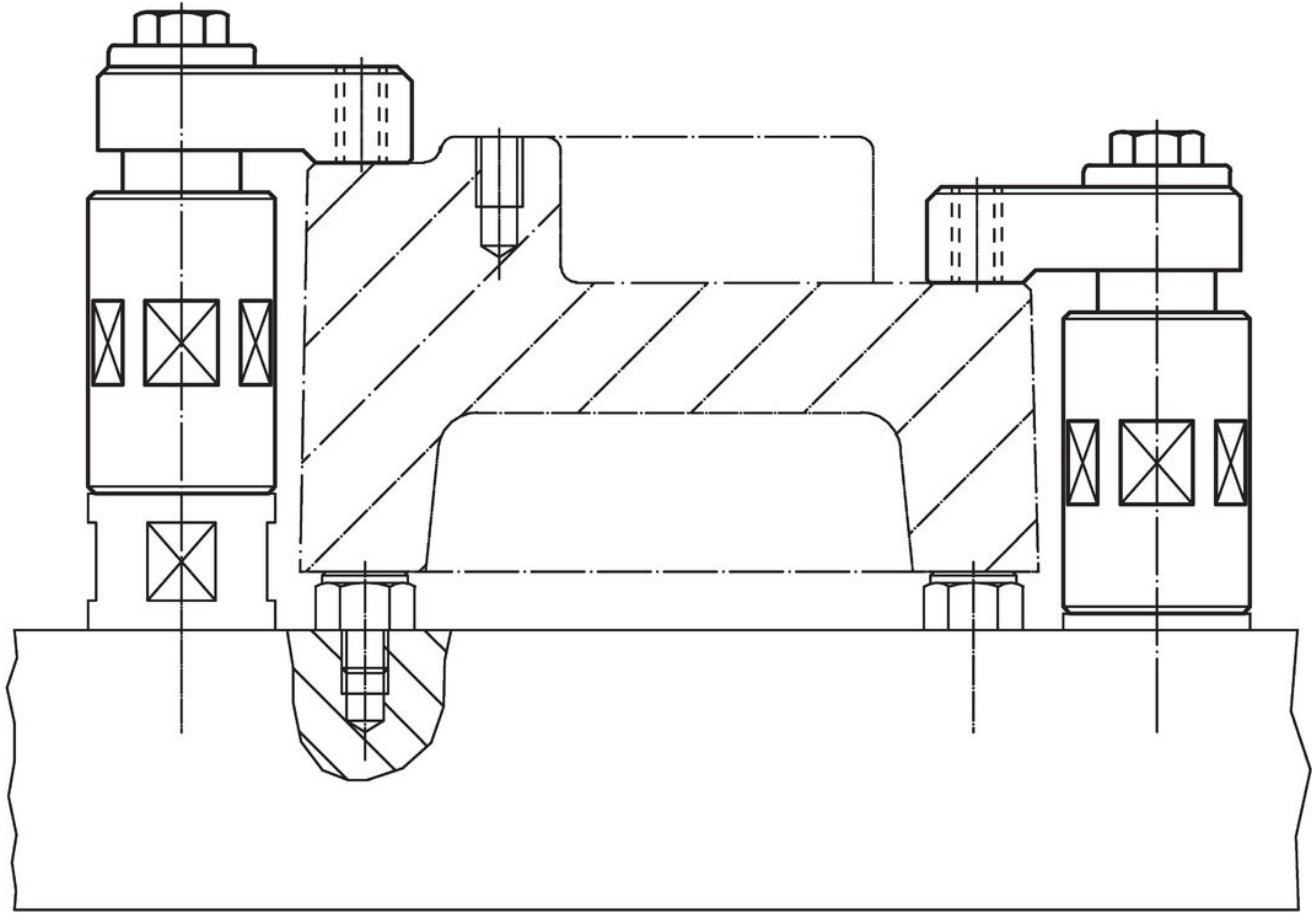

Compliance

RoHS compliant

Contains lead - compliant according to exceptions 6a / 6b / 6c.

Contains SVHC substances >0,1% w/w

Contains lead - SVHC list [REACH] as of 27.06.2024.

Contains Proposition 65 substances



Lead can cause cancer and reproductive harm from exposure
<https://www.P65Warnings.ca.gov/>

Free from Conflict Minerals

This product does not contain any substances designated as "conflict minerals" such as tantalum, tin, gold or tungsten from the Democratic Republic of Congo or adjacent countries.