

Down-Thrust Clamps • swivelling, size 40

23310.0057



Product Description

Universal mechanical clamping element for fast and comfortable changing and clamping of workpieces by means of manually swivelling clamping claw.

The clamps have the following advantages:

- Rapid manual clamping by means of clamping screw, adjustable clamping lever, or double eccentric lever.
- Easy and rapid changing of workpieces by swinging away the clamping claw to the left or right. The positioning ring 23310.0350 allows infinitely variable adjustment.
- Continuously variable setting by means of positioning ring 23310.0350.
- The use of positioning ring 23310.0350 allows a repeatable precise clamping. Here h_1 min. increases by at least 7 mm (stroke minus 7 mm).
- Compact design, thus only a small amount of space is required for clamping.
- Easy adjustment even to large clamping heights due to the height adjusting cylinders.

As the force applied by the operator is not known for the versions with levers, the clamping force is given in the tables as a guide value. The average value was determined by tests.

Material

Clamp

- Case-hardened steel, case-hardened, blackened and ground

Assembly

Down-thrust clamps can be attached in two ways:

1. in a T-slot, using a nut for T-slots DIN 508 (EH 23010.)
2. with the set screw directly in the mounting plate of, for example, a fixture

The cylinder must make contact over the whole surface.

Exceeding of the clamping height is inhibited by the height limitation.

More information

References

The clamping height can be increased by using height adjusting cylinders EH 23310. and disks EH 1107. and EH 1108. It can be reduced by employing clamping inserts, e.g. EH 22730.

Further products

- Positioning Rings, for down-thrust clamp
- Height Adjusting Cylinders
- Spacers
- Wrenches

Drawing

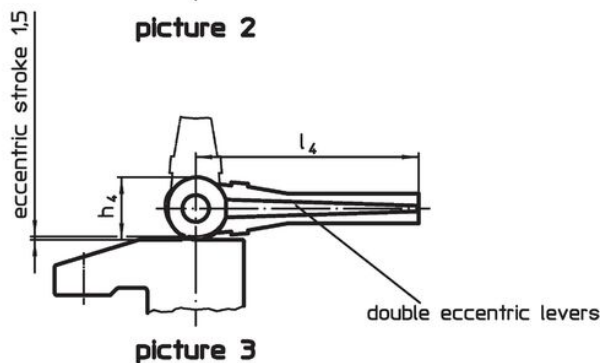
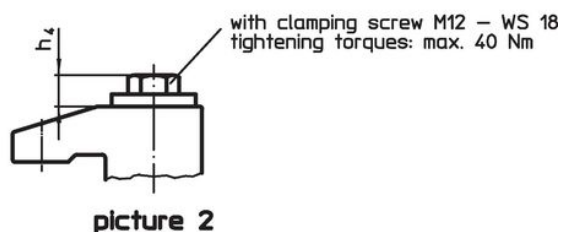
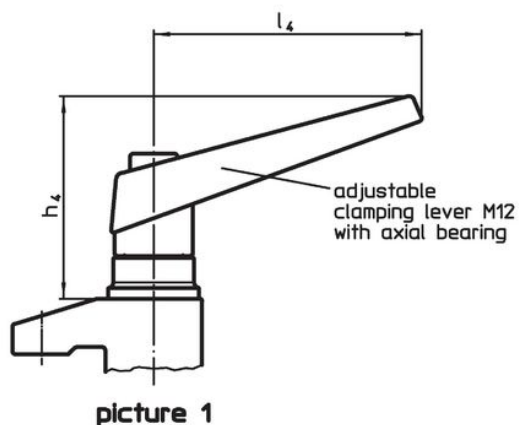
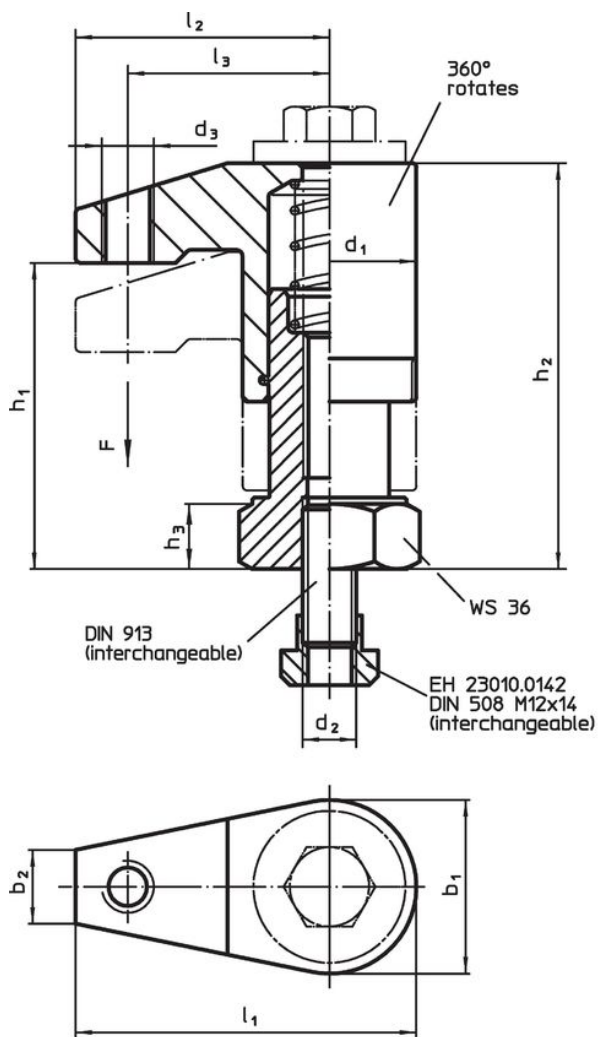

Order information

Dimensions												Stroke	Clamping force	Tightening torque max.	Art. No.	
d ₁	b ₁	b ₂	d ₂	d ₃	h ₁	h ₂	h ₃	h ₄	l ₁	l ₂	l ₃					[mm]
with clamping screw – picture 2																
40	40	17	M12	M12	95 – 135	118 – 158	22	13	75	55	43	40	10	40	1266	23310.0057

Application example



Compliance

RoHS compliant

Contains lead - compliant according to exceptions 6a / 6b / 6c.

Contains SVHC substances >0,1% w/w

Contains lead - SVHC list [REACH] as of 23.01.2024.

Contains Proposition 65 substances



Lead can cause cancer and reproductive harm from exposure
<https://www.P65Warnings.ca.gov/>

Free from Conflict Minerals

This product does not contain any substances designated as "conflict minerals" such as tantalum, tin, gold or tungsten from the Democratic Republic of Congo or adjacent countries.