

Pitbull® Clamps

23290.0062



Product Description

Pitbull® Clamps are robust clamps of high quality and deliver extremely high clamping forces when used for workholding. During this type of application, they also produce a strong pull-down effect.

The knife edge version (picture 1) is especially suited for blanks.

The blunt edged version (picture 2) allows you to cover nearly all types of application. The version made of brass provides for clamping that is gentle, yet secure.

The Pitbull® Clamp with machinable edge (picture 3) has been designed with a machining add-on that allows for a contour to be milled into the workpiece. This version from hardened steel combines good machinability with excellent wear resistance.

The Pitbull® Clamps are distinguished by the following characteristics:

- space-saving design
- extra low construction height
- high clamping / tensioning force with pull-down effect
- ideal for multi-side machining and multiple clamping systems

Material

Clamp

- Steel, hardened

Screw

- Heat-treated steel, tempered

O-ring

- NBR

More information

Notes

The o-ring is used to lift the clamp off when it is released.

Drawing

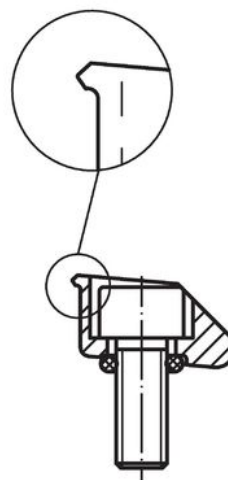
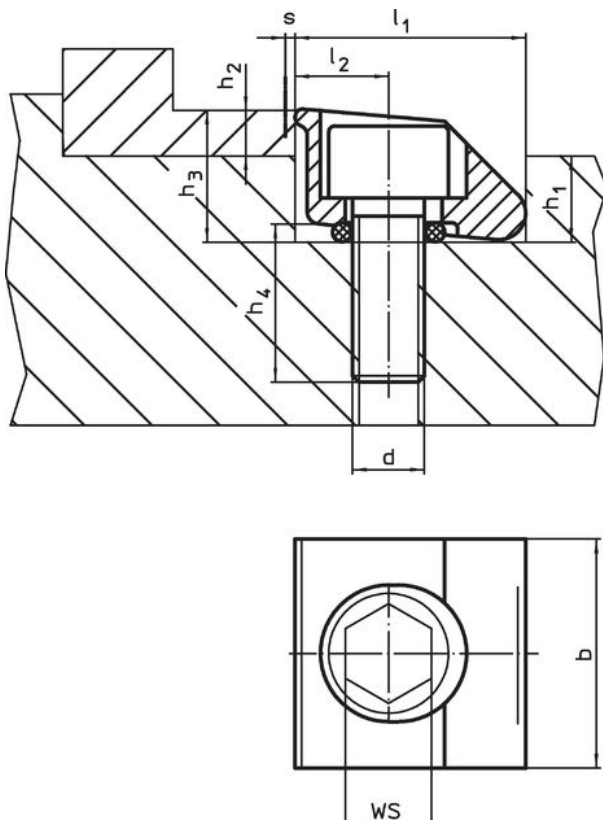

picture 1

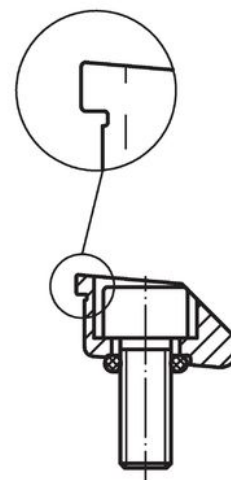

picture 2

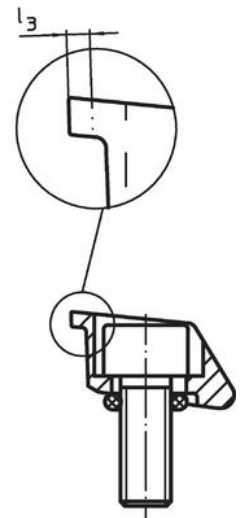

picture 3

Order information

Dimensions								Clamping way s	WS	Clamping force max.	Tightening torque max.	Temperature		Weight [g]	Art. No.
d	b	l ₁ H9	l ₂	h ₁	h ₂ min.	h ₃ ~	h ₄ ~					min.	max.		
[mm]								[mm]	[mm]	[kN]	[Nm]	[°C]		[g]	
blunt edged – picture 2, Steel															
M4	12.7	12.7	5.1	4.8	2.6	7.4	8	0.4	3	2.6	6	-30	80	6.2	23290.0062

Application example

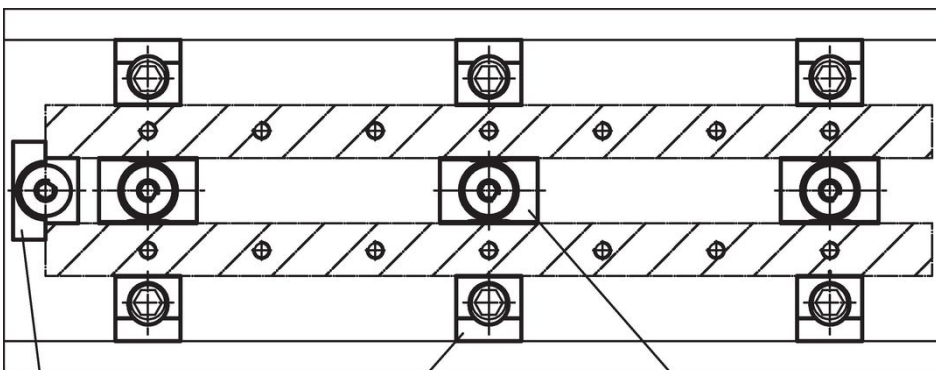

Stop
23290.0104

Pitbull-Clamp
e.g. 23290.0052

Clamping Claw
e.g. 23290.0101

Compliance

RoHS compliant

Compliant according to Directive 2011/65/EU and Directive 2015/863.

Does not contain SVHC substances

No SVHC substances with more than 0.1% w/w contained - SVHC list [REACH] as of 23.01.2024.

Does not contain Proposition 65 substances

No Proposition 65 substances included.

<https://www.P65Warnings.ca.gov/>

Free from Conflict Minerals

This product does not contain any substances designated as "conflict minerals" such as tantalum, tin, gold or tungsten from the Democratic Republic of Congo or adjacent countries.