

Locating Clamps

23230.0040



Product Description

Suitable for a simultaneous "positioning" and "clamping" of workpieces. The locating element is a precision element which can be assembled from either side. The clamping and locating part adapted to the workpiece is screwed to the cylindrical support. Clamping and locating parts are manufactured by the user according to the individual requirements.

Material

Handle

- Grey cast iron DIN 6335, orange plastic-coated

Clamp

- Steel, case-hardened, blackened, ground

Drawing

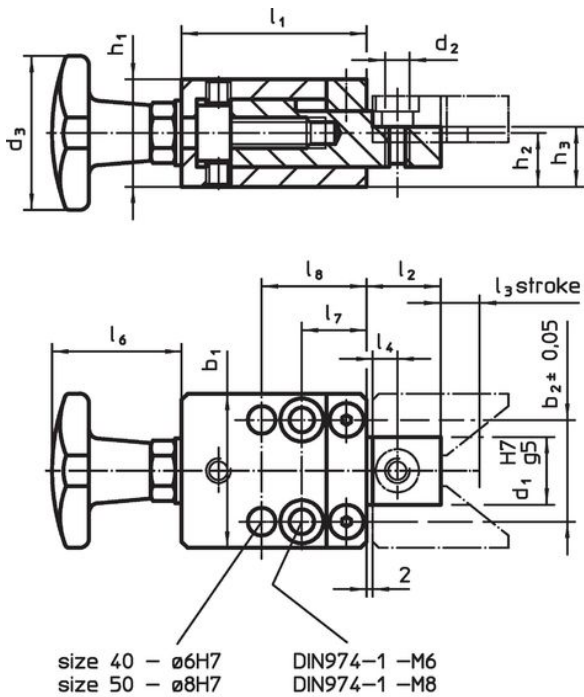

picture 1

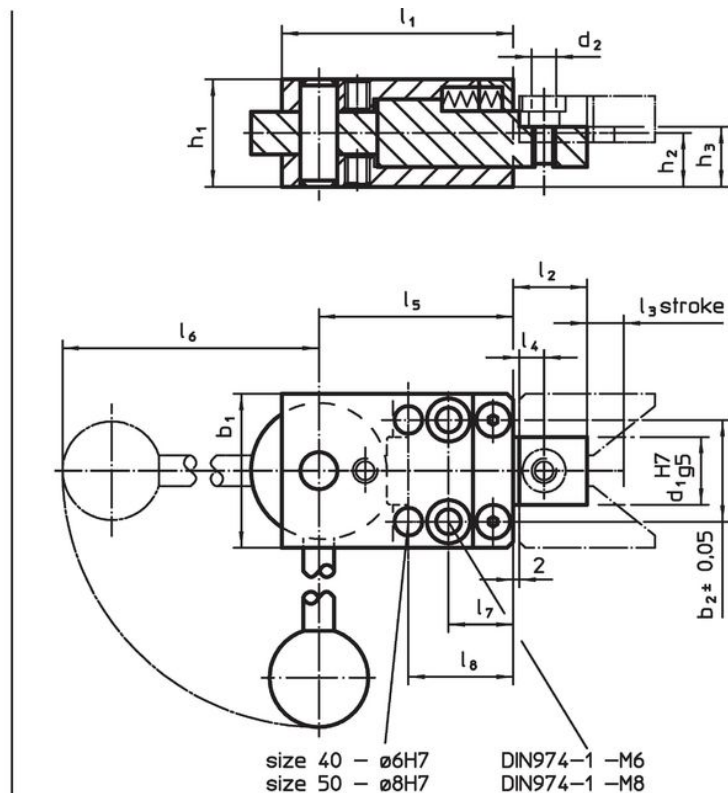

picture 2

Order information

Dimensions														[g]	Art. No.	
b ₁	b ₂ ±0.05	d ₁ H7 g5	d ₂	d ₃	h ₁	h ₂	h ₃	l ₁	l ₂	l ₃	l ₄	l ₆	l ₇			l ₈
[mm]																
with palm grip – picture 1																
40	27	18	M6	40	29.8	14.9	16.9	50	19	9	8	33	17	28	505	23230.0040

Application example



Compliance

RoHS compliant

Compliant according to Directive 2011/65/EU and Directive 2015/863.

Does not contain SVHC substances

No SVHC substances with more than 0.1% w/w contained - SVHC list [REACH] as of 23.01.2024.

Does not contain Proposition 65 substances

No Proposition 65 substances included.

<https://www.P65Warnings.ca.gov/>

Free from Conflict Minerals

This product does not contain any substances designated as "conflict minerals" such as tantalum, tin, gold or tungsten from the Democratic Republic of Congo or adjacent countries.