

Clamps · with exchangeable soft jaw
23190.0075



Product Description

This clamp (clamping claw) with exchangeable soft jaw is mainly used in mechanical clamping technology for clamping workpieces. The soft jaw made from brass or plastic protects the workpiece from damage.

Material

Soft jaw
• plastic

Assembly

The soft jaws are mounted or disassembled with two screws. These are included in the scope of delivery.

Drawing

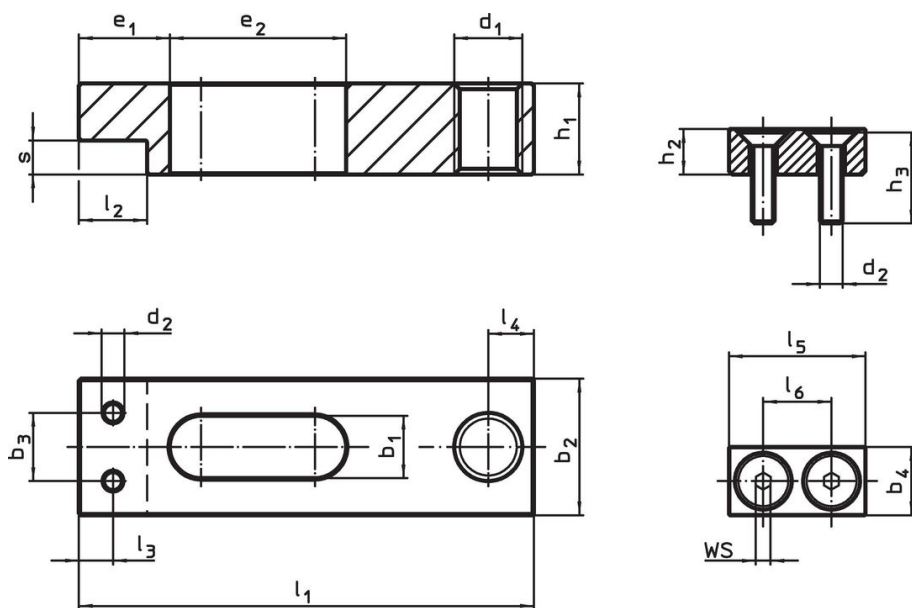

picture 1

picture 2

Order information

Nominal dimension b_1 +0.5 [mm]	Dimensions						WS [mm]	Temperature		Weight [g]	Art. No.
	b_4	d_2	h_2	h_3	l_5	l_6		min.	max.		
	[mm]							[°C]			
soft jaw from plastic – picture 2											
18	28	M8	16	30	50	30	5	0	50	49	23190.0075

Application example



Compliance

RoHS compliant

Compliant according to Directive 2011/65/EU and Directive 2015/863.

Does not contain SVHC substances

No SVHC substances with more than 0.1% w/w contained - SVHC list [REACH] as of 23.01.2024.

Does not contain Proposition 65 substances

No Proposition 65 substances included.
<https://www.P65Warnings.ca.gov/>

Free from Conflict Minerals

This product does not contain any substances designated as "conflict minerals" such as tantalum, tin, gold or tungsten from the Democratic Republic of Congo or adjacent countries.