

Clamps · with exchangeable soft jaw

23190.0050



Product Description

This clamp (clamping claw) with exchangeable soft jaw is mainly used in mechanical clamping technology for clamping workpieces. The soft jaw made from brass or plastic protects the workpiece from damage.

Material

Clamp

- Heat-treated steel, blackened

Assembly

The soft jaws are mounted or disassembled with two screws. These are included in the scope of delivery.

Drawing

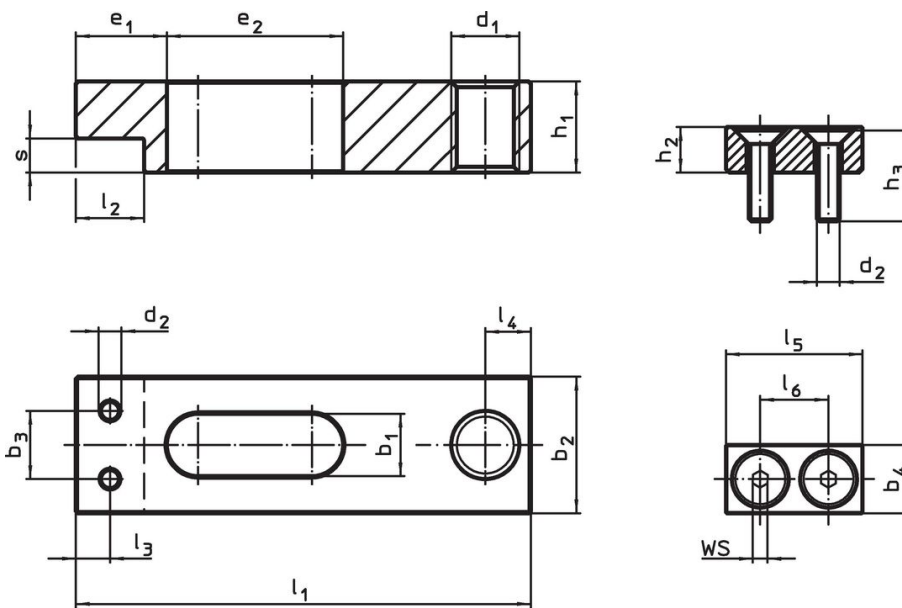

picture 1

picture 2

Order information

Nominal dimension b_1 +0.5 [mm]	Dimensions													Art. No.	
	l_1	b_2	b_3	d_1	d_2	e_1	e_2	h_1	l_2	l_3	l_4	s	[g]		
plain clamp without soft jaw – picture 1															
5.5	40	12	6	M6	M2	8	15.5	8	6	3	4	3	21	23190.0050	

Application example



Compliance

RoHS compliant

Contains lead - compliant according to exceptions 6a / 6b / 6c.

Contains SVHC substances >0,1% w/w

Contains lead - SVHC list [REACH] as of 23.01.2024.

Contains Proposition 65 substances



Lead can cause cancer and reproductive harm from exposure
<https://www.P65Warnings.ca.gov/>

Free from Conflict Minerals

This product does not contain any substances designated as "conflict minerals" such as tantalum, tin, gold or tungsten from the Democratic Republic of Congo or adjacent countries.