

Clamps · with nose  
23180.0109



Product Description

This clamp (clamping claw) with nose is mainly used in mechanical clamping technology for clamping workpieces.

Material

- Heat-treated steel, tempered, blackened

Drawing

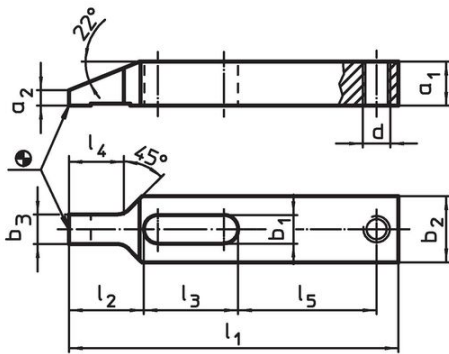

picture 1

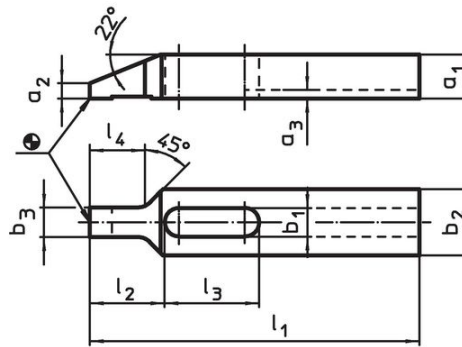

picture 2

Order information

Nominal dimension b <sub>1</sub> [mm]	Dimensions										Art. No.	
	l <sub>1</sub>	a <sub>1</sub>	a <sub>2</sub>	b <sub>2</sub>	b <sub>3</sub>	d	l <sub>2</sub>	l <sub>3</sub>	l <sub>4</sub>	l <sub>5</sub>		[g]
with thread for adjusting screw – picture 1												
9	100	12	4	20	9.5	M8	22	29	17	42	133	23180.0109

Application example

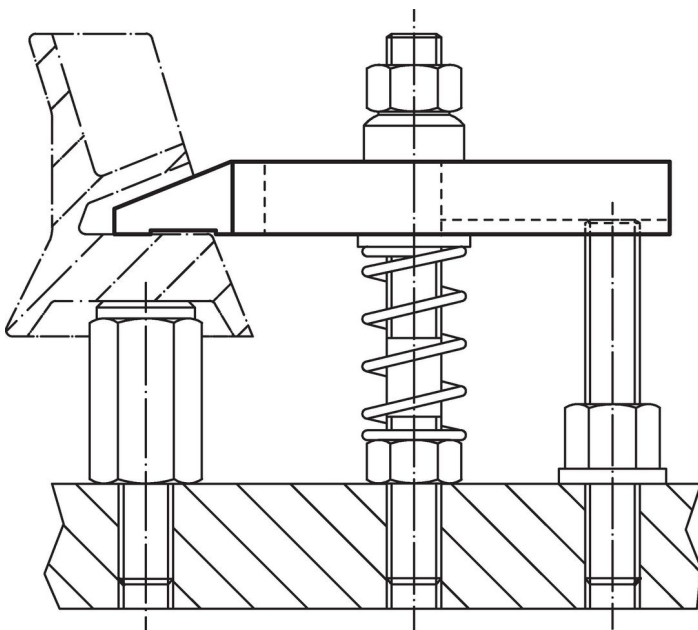

## Compliance

### RoHS compliant

Compliant according to Directive 2011/65/EU and Directive 2015/863.

### Does not contain SVHC substances

No SVHC substances with more than 0.1% w/w contained - SVHC list [REACH] as of 23.01.2024.

### Does not contain Proposition 65 substances

No Proposition 65 substances included.

<https://www.P65Warnings.ca.gov/>

### Free from Conflict Minerals

This product does not contain any substances designated as "conflict minerals" such as tantalum, tin, gold or tungsten from the Democratic Republic of Congo or adjacent countries.