

Clamps • DIN 6315 B forked

23150.0040



Product Description

This clamp (clamping claw) according to DIN 6314 B is forked and is mainly used in mechanical clamping technology for clamping workpieces.

Material

- Heat-treated steel, varnished

Drawing

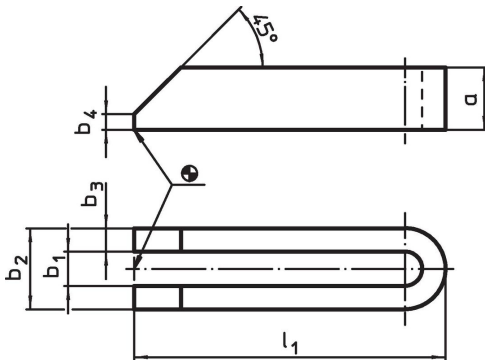

Order information

Nominal dimension b ₁ [mm]	Dimensions					For screws		[g]	Art. No. ¹⁾
	l ₁	a	b ₂ [mm]	b ₃	b ₄	[mm]	[in]		
40	400	60	100	30	12	M36	1 1/2	10920	23150.0040

¹⁾ DIN standards do not include these dimensions.

Compliance

RoHS compliant

Compliant according to Directive 2011/65/EU and Directive 2015/863.

Does not contain SVHC substances

No SVHC substances with more than 0.1% w/w contained - SVHC list [REACH] as of 23.01.2024.

Does not contain Proposition 65 substances

No Proposition 65 substances included.
<https://www.P65Warnings.ca.gov/>

Free from Conflict Minerals

This product does not contain any substances designated as "conflict minerals" such as tantalum, tin, gold or tungsten from the Democratic Republic of Congo or adjacent countries.