

Clamps · DIN 6314 flat
23140.0015



Product Description

This clamp (clamping claw) according to DIN 6314 is mainly used in mechanical clamping technology for clamping workpieces.

Material

- Heat-treated steel, varnished

Drawing

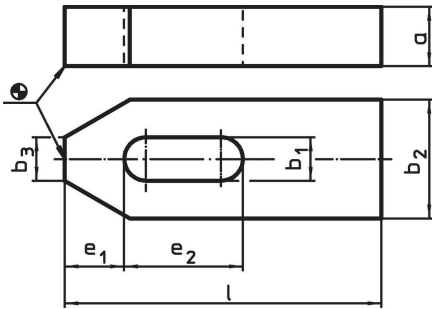

Order information

Nominal dimension b ₁ [mm]	Dimensions						For screws		[g]	Art. No.
	l	a	b ₂ [mm]	b ₃	e ₁	e ₂	[mm]	[in]		
14	125	20	40	14	21	50	M12, M14	1/2	623	23140.0015

Application example

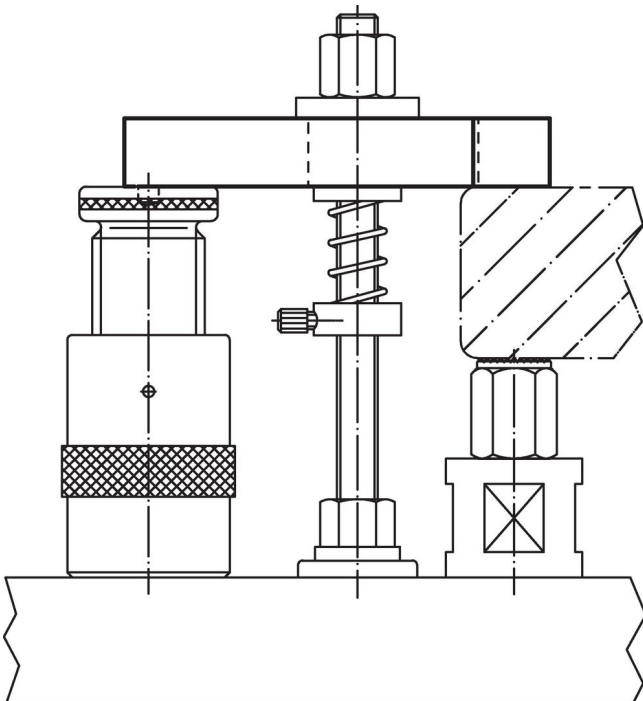

Compliance

RoHS compliant

Compliant according to Directive 2011/65/EU and Directive 2015/863.

Does not contain SVHC substances

No SVHC substances with more than 0.1% w/w contained - SVHC list [REACH] as of 23.01.2024.

Does not contain Proposition 65 substances

No Proposition 65 substances included.

<https://www.P65Warnings.ca.gov/>

Free from Conflict Minerals

This product does not contain any substances designated as "conflict minerals" such as tantalum, tin, gold or tungsten from the Democratic Republic of Congo or adjacent countries.