

Loose Slot Tenons · DIN 6323

23120.0014



Product Description

To be used for locating fixtures and clamping elements onto machine tables with T-slots to DIN 650.

Being simply pushed into position after fixture or clamping element has been roughly positioned, they cannot cause damage to the machine as could protruding fixed slot tenons or low slot tenons.

Material

- Steel, case-hardened, blackened, ground

Drawing

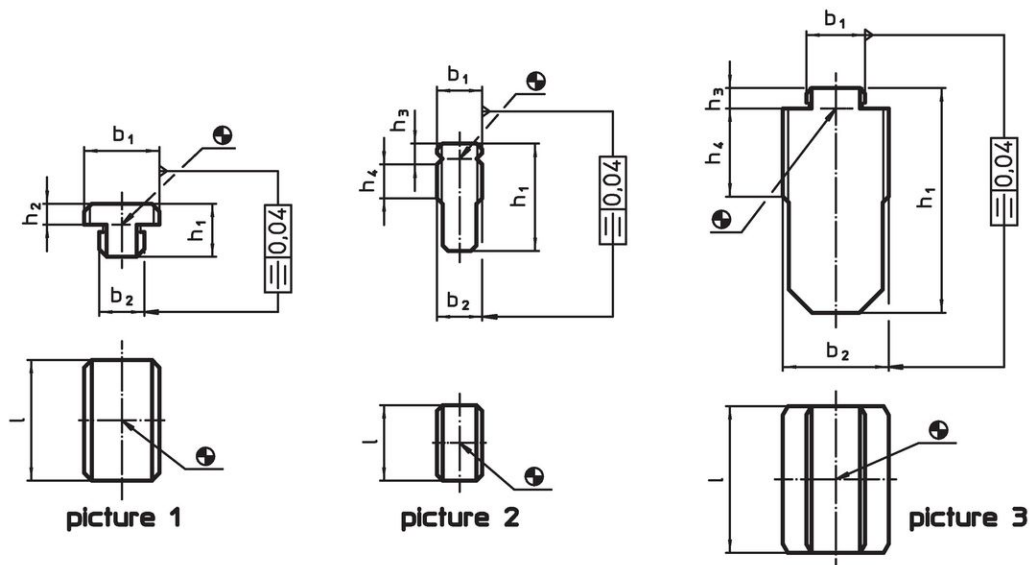

Order information

T-slot size fixture b ₁ h ₆ [mm]	T-slot size machine b ₂ h ₆ [mm]	h ₁	Dimensions		[g]	Art. No.
			h ₂	l		
form A, b ₁ > b ₂ – picture 1						
20	14	14	5.5	32	56	23120.0014

Application example

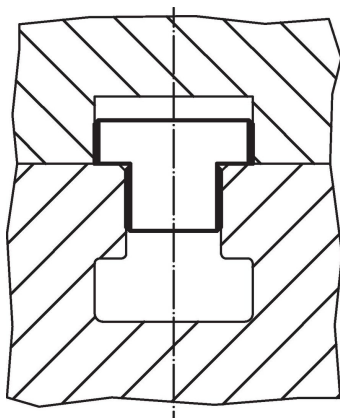



Compliance

RoHS compliant

Compliant according to Directive 2011/65/EU and Directive 2015/863.

Does not contain SVHC substances

No SVHC substances with more than 0.1% w/w contained - SVHC list [REACH] as of 23.01.2024.

Does not contain Proposition 65 substances

No Proposition 65 substances included.

<https://www.P65Warnings.ca.gov/>

Free from Conflict Minerals

This product does not contain any substances designated as "conflict minerals" such as tantalum, tin, gold or tungsten from the Democratic Republic of Congo or adjacent countries.