

Manual Handles • for positioning clamping pins

23111.0900



Product Description

The manual handle enables an easy and fast operation of the positioning clamping pin.

Material

- Stainless steel

Assembly

The handle is tightened to the positioning clamping pin with the M 4 screw included in the delivery.

Drawing

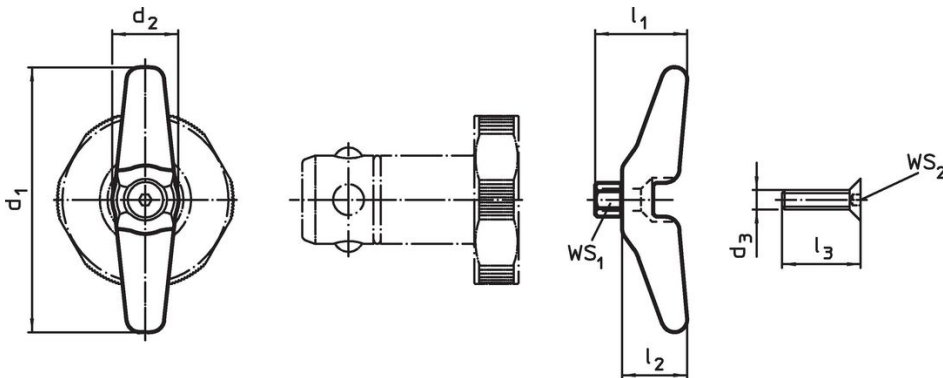

Order information

For pin Ø [mm]	Dimensions						WS ₁ [mm]	WS ₂ [mm]	[g]	Art. No.
	d ₁	d ₂	d ₃	l ₁	l ₂	l ₃				
16/20	60	15	M4	20	15	16	6	2.5	48	23111.0900

Application example



Compliance

RoHS compliant

Compliant according to Directive 2011/65/EU and Directive 2015/863.

Does not contain SVHC substances

No SVHC substances with more than 0.1% w/w contained - SVHC list [REACH] as of 23.01.2024.

Does not contain Proposition 65 substances

No Proposition 65 substances included.
<https://www.P65Warnings.ca.gov/>

Free from Conflict Minerals

This product does not contain any substances designated as "conflict minerals" such as tantalum, tin, gold or tungsten from the Democratic Republic of Congo or adjacent countries.