

Drive Blocks • DIN 2079
23100.0045



Product Description

These drive blocks are manufactured according to DIN 2079.

Material

- Alloyed case-hardened steel, case-hardened, blackened, ground

Drawing

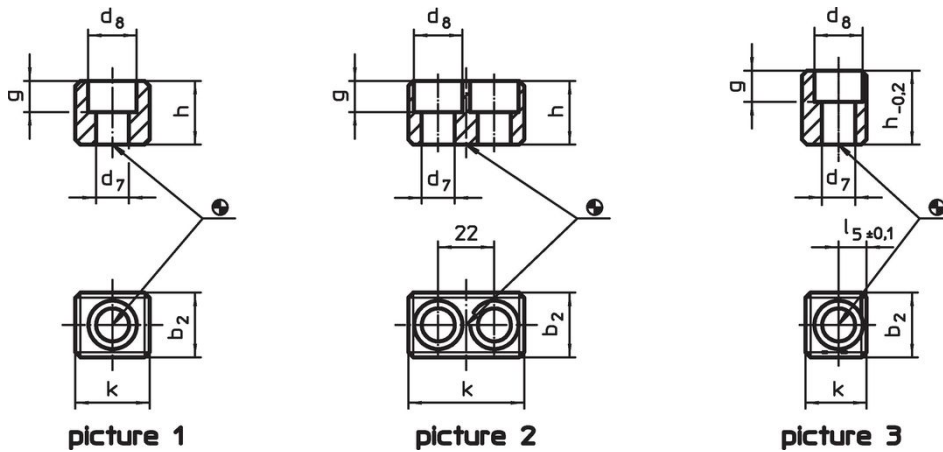

Order information

Spindle head No.	Dimensions						For screws ISO 4762	[g]	Art. No.
	k	b ₂ h5	d ₇	d ₈	g	h			
for spindle heads no. 30 to 60, form A – picture 1									
45	19.5	19	8.4	13.5	8.3	19	M8 x 20	40	23100.0045

Application example

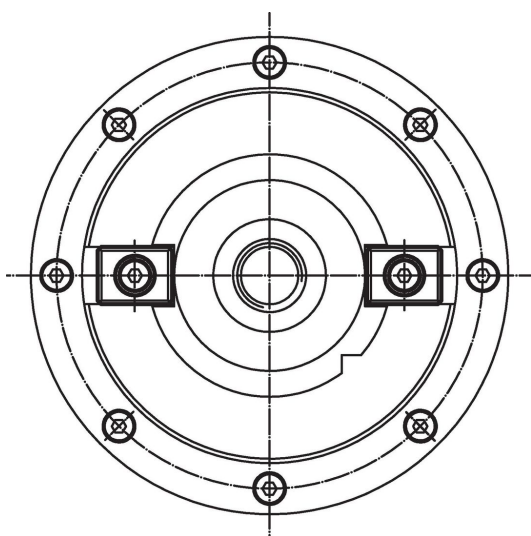

Compliance

RoHS compliant

Compliant according to Directive 2011/65/EU and Directive 2015/863.

Does not contain SVHC substances

No SVHC substances with more than 0.1% w/w contained - SVHC list [REACH] as of 27.06.2024.

Does not contain Proposition 65 substances

No Proposition 65 substances included.

<https://www.P65Warnings.ca.gov/>

Free from Conflict Minerals

This product does not contain any substances designated as "conflict minerals" such as tantalum, tin, gold or tungsten from the Democratic Republic of Congo or adjacent countries.