

Collar Nuts with Conical Seat

23080.0520



Product Description

With this combination of fixture nut and conical seat, non-parallel clamping surfaces can be compensated.

The fixture nut with conical seat is a fixed unit consisting of fixture nut and conical seat with the following advantages / characteristics:

- Functionally reliable
- Captive
- Fast and efficient mounting
- Simplified storage
- Swivel range max. 3°

Material

Conical seat

- Heat-treated steel, tempered, blackened

Nut

- Heat-treated steel, tempered, blackened

More information

References

For torques and strengths please refer to appendix - Technical Data -

Drawing

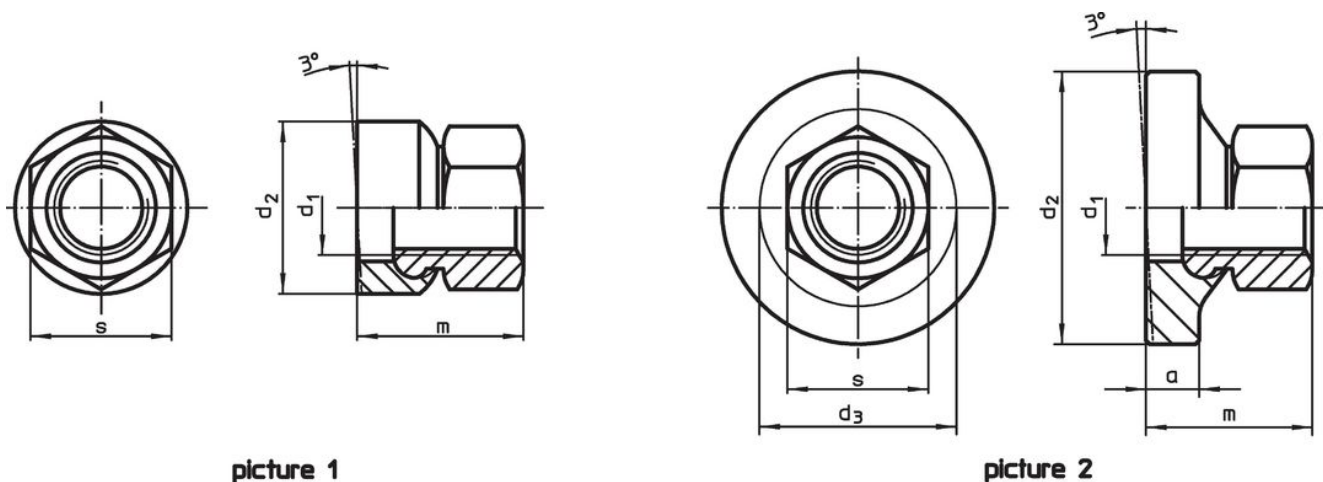

picture 1

picture 2

Order information

d ₁	Dimensions		m	s		Art. No.
	d ₂	[mm]				
with small bearing surface – picture 1						
M20	36		35	30	141	23080.0520

Application example



Compliance

RoHS compliant

Compliant according to Directive 2011/65/EU and Directive 2015/863.

Does not contain SVHC substances

No SVHC substances with more than 0.1% w/w contained - SVHC list [REACH] as of 27.06.2024.

Does not contain Proposition 65 substances

No Proposition 65 substances included.

<https://www.P65Warnings.ca.gov/>

Free from Conflict Minerals

This product does not contain any substances designated as "conflict minerals" such as tantalum, tin, gold or tungsten from the Democratic Republic of Congo or adjacent countries.