

Collar Nuts • DIN 6331 (height 1,5 d)
23080.0016



Product Description

The collar nuts (flanged nuts) are manufactured according to DIN 6331.

Material

- Heat-treated steel, tempered, quality 10, phosphated

More information

References

For torques and strengths please refer to appendix - Technical Data -

Drawing

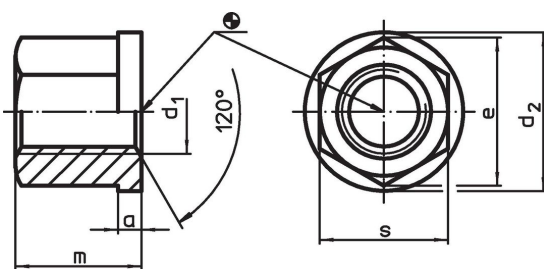

Order information

Dimensions							Art. No.
d ₁	a	d ₂	e	m	s	[g]	
Heat-treated steel							
M16	5	31	27.7	24	24	67	23080.0016

Application example

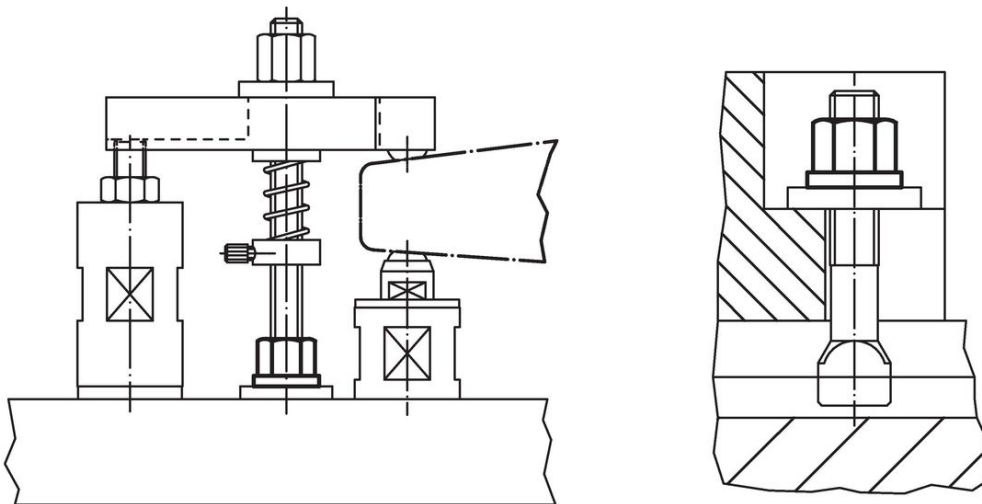

Compliance

RoHS compliant

Compliant according to Directive 2011/65/EU and Directive 2015/863.

Does not contain SVHC substances

No SVHC substances with more than 0.1% w/w contained - SVHC list [REACH] as of 23.01.2024.

Does not contain Proposition 65 substances

No Proposition 65 substances included.

<https://www.P65Warnings.ca.gov/>

Free from Conflict Minerals

This product does not contain any substances designated as "conflict minerals" such as tantalum, tin, gold or tungsten from the Democratic Republic of Congo or adjacent countries.