

## Fixture Nuts • DIN 6330 (height 1,5 d)

23070.0016



### Product Description

Fixture nuts according to DIN 6330 have a spherical surface to match conical seats DIN 6319 (EH 23050.).

With this combination of fixture nut and conical seat, non-parallel clamping surfaces can be compensated.

### Material

- Heat-treated steel, tempered, quality 10, phosphated

### More information

### References

For torques and strengths please refer to appendix - Technical Data -

### Drawing

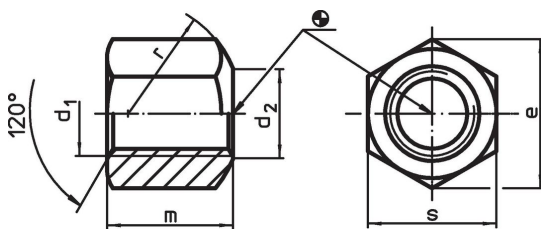

### Order information

d <sub>1</sub>	d <sub>2</sub>	Dimensions				[g]	Art. No.
		e	m	r	s		
with lateral spherical bearing surface, form B, Heat-treated steel							
M16	18	27.7	24	22	24	55	23070.0016

### Application example

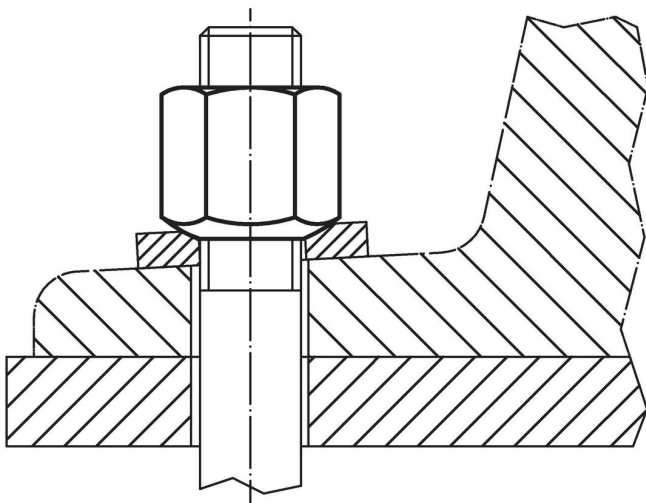

## Compliance

### RoHS compliant

Compliant according to Directive 2011/65/EU and Directive 2015/863.

### Does not contain SVHC substances

No SVHC substances with more than 0.1% w/w contained - SVHC list [REACH] as of 23.01.2024.

### Does not contain Proposition 65 substances

No Proposition 65 substances included.

<https://www.P65Warnings.ca.gov/>

### Free from Conflict Minerals

This product does not contain any substances designated as "conflict minerals" such as tantalum, tin, gold or tungsten from the Democratic Republic of Congo or adjacent countries.