

Shaft / Plain Washers • DIN 6340 heat-treated

23060.0024



Product Description

The heat-treated shaft / plain washers (washers) are manufactured according to DIN 6340.

Material

- Heat-treated steel, tempered, punched, mechanically trued, phosphatized

Drawing

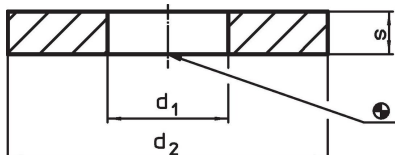

Order information

d ₁	Dimensions		s	For screws	[g]	Art. No.
	d ₂	[mm]		[mm]		
25	60		8	M24	122	23060.0024

Application example

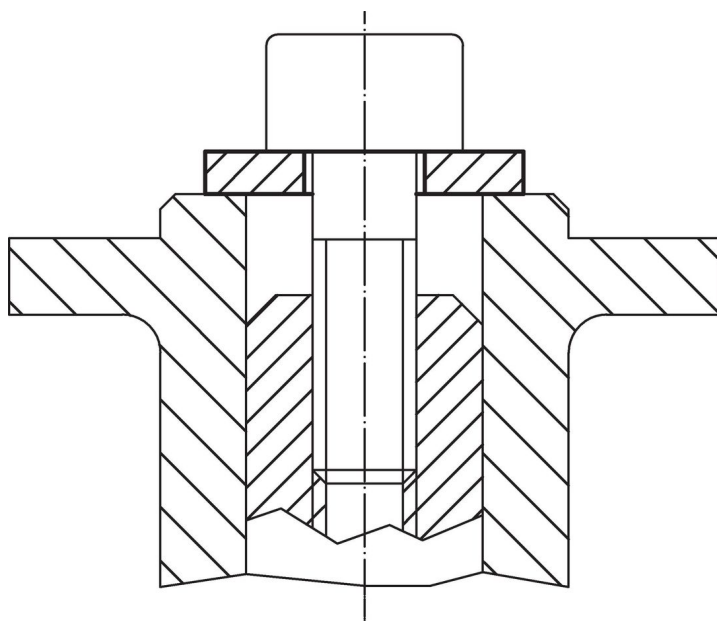

Compliance

RoHS compliant

Compliant according to Directive 2011/65/EU and Directive 2015/863.

Does not contain SVHC substances

No SVHC substances with more than 0.1% w/w contained - SVHC list [REACH] as of 23.01.2024.

Does not contain Proposition 65 substances

No Proposition 65 substances included.

<https://www.P65Warnings.ca.gov/>

Free from Conflict Minerals

This product does not contain any substances designated as "conflict minerals" such as tantalum, tin, gold or tungsten from the Democratic Republic of Congo or adjacent countries.