

## Spherical Washers / Conical Seats • similar to DIN 6319, stainless steel

23050.0470



### Product Description

Spherical washers / Conical seats are used as washers in a screw connection to compensate non-parallel surfaces.

### Material

#### Conical seat

- Stainless steel 1.4305

### Assembly

Conical seats form D are to be used only for plain, closed round areas.  
For larger holes only use form G!

### Characteristic

Types from stainless steel A4 with marking (knurling) according drawing.

### More information

### Further products

- Spherical Washers / Conical Seats, DIN 6319
- Fixture Nuts, DIN 6330 (height 1,5 d)

### Drawing

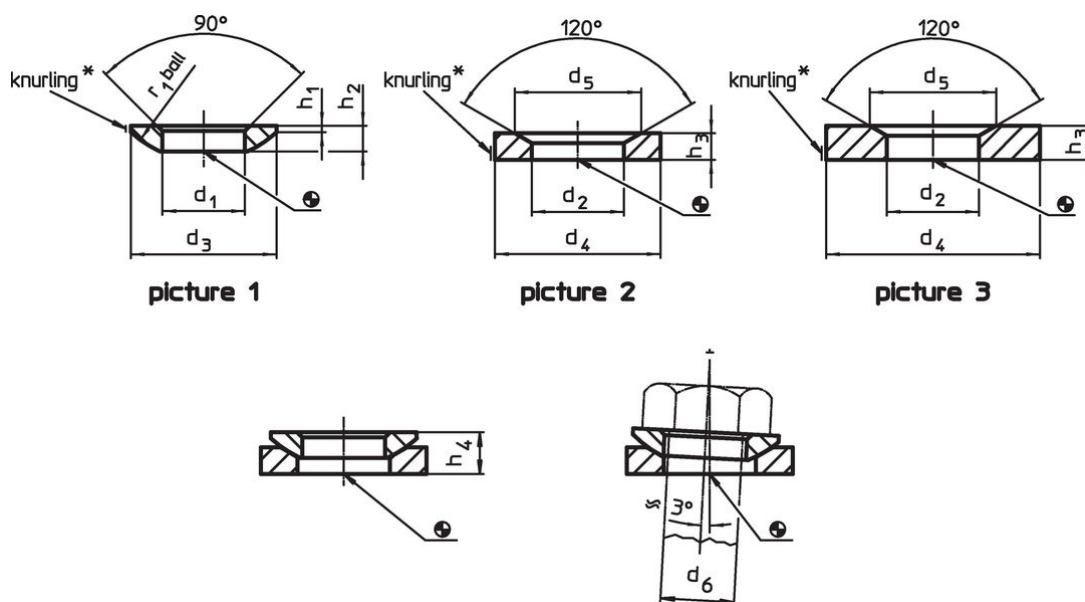

\* Knurling = material identification for stainless steel A4 type

### Order information

d <sub>2</sub> H13	Dimensions			For pin d <sub>6</sub> [mm]	For screws d <sub>6</sub> [mm]	Load capacity for static load max. [kN]	Torque for screwed connections <sup>1)</sup> max. [Nm]	[g]	Art. No.
	d <sub>4</sub> [mm]	d <sub>5</sub> [mm]	h <sub>3</sub> [mm]						
conical seats from stainless steel, form G – picture 3, Stainless steel 1.4305									
12	30	18.5	5	10	M10	16	32	22	23050.0470

<sup>1)</sup> Torques of screws with standard thread, eventual pre-loads to be considered, coefficient of friction  $\mu_{total}$  0.14.

### Application example



### Compliance

#### RoHS compliant

Compliant according to Directive 2011/65/EU and Directive 2015/863.

#### Does not contain SVHC substances

No SVHC substances with more than 0.1% w/w contained - SVHC list [REACH] as of 23.01.2024.

#### Does not contain Proposition 65 substances

No Proposition 65 substances included.  
<https://www.P65Warnings.ca.gov/>

#### Free from Conflict Minerals

This product does not contain any substances designated as "conflict minerals" such as tantalum, tin, gold or tungsten from the Democratic Republic of Congo or adjacent countries.