

Swing Bolts • DIN 444, form B, quality 8.8 high precision design

22980.0106



Product Description

The high precision design swing bolts exceed the DIN Version's quality. The thread is rolled - the shaft diameter is equal to the roll diameter. The surfaces -s- are machined.
Bore tolerance $d_2 = H7$.

Material

- Heat-treated steel, tempered, quality 8.8, black

More information

References

For torques please refer to appendix - Technical Data -

Further products

- Swing Bolts, DIN 444, form B

Drawing

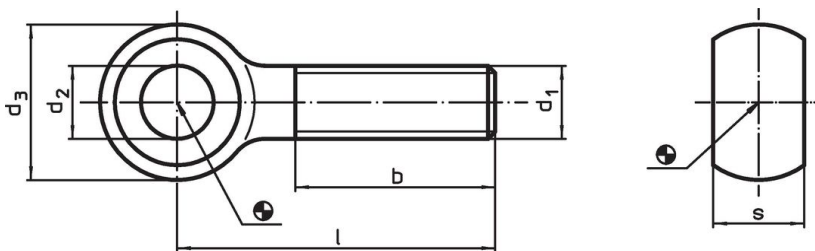

Order information

Dimensions						[g]	Art. No.
d_1	l	d_2 H7	d_3	b	s -0.2		
M10	75	10	20	26	12	50	22980.0106

Application example

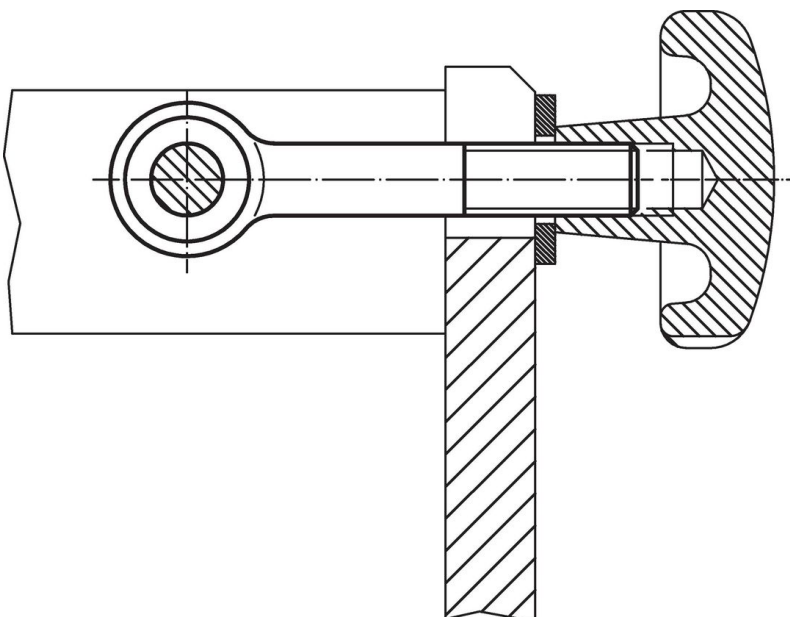

Compliance

RoHS compliant

Compliant according to Directive 2011/65/EU and Directive 2015/863.

Does not contain SVHC substances

No SVHC substances with more than 0.1% w/w contained - SVHC list [REACH] as of 23.01.2024.

Does not contain Proposition 65 substances

No Proposition 65 substances included.

<https://www.P65Warnings.ca.gov/>

Free from Conflict Minerals

This product does not contain any substances designated as "conflict minerals" such as tantalum, tin, gold or tungsten from the Democratic Republic of Congo or adjacent countries.