

Distance Bushings · for Expander sealing plugs with elongated pull-anchor

22880.0429



Product Description

To be used for Expander® sealing plugs with elongated pull-anchor.

Material

Body

- Case-hardened steel, case-hardened

Drawing



Order information

Dimensions		[g]	Art. No.
d ₁	d ₂		
9	5.2	9.6	22880.0429

Application example

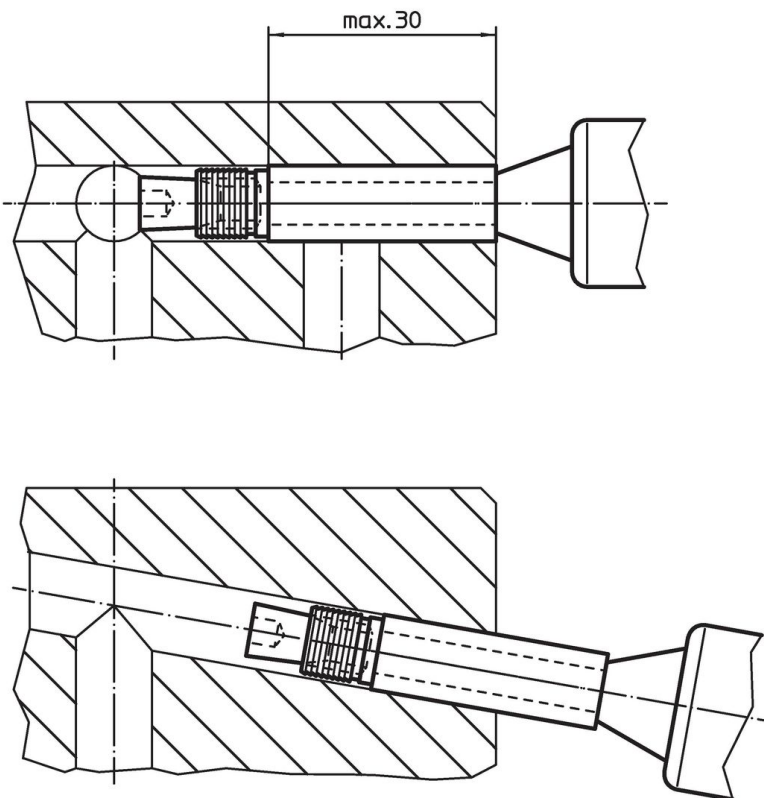

Compliance

RoHS compliant

Compliant according to Directive 2011/65/EU and Directive 2015/863.

Does not contain SVHC substances

No SVHC substances with more than 0.1% w/w contained - SVHC list [REACH] as of 27.06.2024.

Does not contain Proposition 65 substances

No Proposition 65 substances included.

<https://www.P65Warnings.ca.gov/>

Free from Conflict Minerals

This product does not contain any substances designated as "conflict minerals" such as tantalum, tin, gold or tungsten from the Democratic Republic of Congo or adjacent countries.