

## Setting Dies • for Expander sealing plug

22880.0168



### Product Description

Expander® sealing plugs are used for safe, quick and economic sealing of bore holes in fluid technology, e.g. hydraulic drilling holes in jig and fixture construction. Assembly is effected by pressing in the sealing plug into the drilling hole by means of the prescribed setting die.  
**Please refer to the technical data following these product information pages.**

### Material

- Tool steel, heat-treated

### Drawing

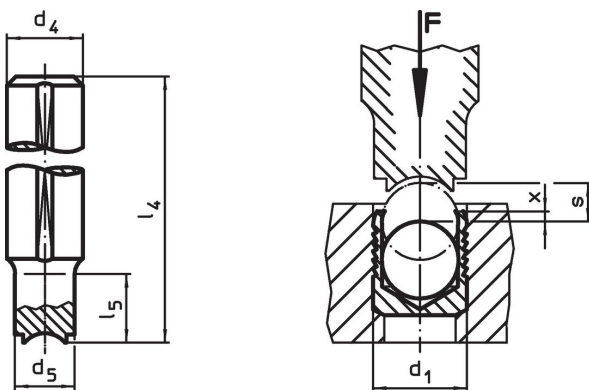

### Order information

d <sub>1</sub>	d <sub>4</sub> h9	d <sub>5</sub>	Dimensions				[g]	Art. No.
			l <sub>4</sub>	l <sub>5</sub>	x ±0.2	s		
18	20	17.7	150	45	0.6	340	22880.0168	

### Application example



## Compliance

### RoHS compliant

Compliant according to Directive 2011/65/EU and Directive 2015/863.

### Does not contain SVHC substances

No SVHC substances with more than 0.1% w/w contained - SVHC list [REACH] as of 23.01.2024.

### Does not contain Proposition 65 substances

No Proposition 65 substances included.

<https://www.P65Warnings.ca.gov/>

### Free from Conflict Minerals

This product does not contain any substances designated as "conflict minerals" such as tantalum, tin, gold or tungsten from the Democratic Republic of Congo or adjacent countries.