

Ball Casters • screwable, plain bearing

22752.0161



Product Description

For positioning and aligning of workpieces.
Because of the slide bearing, the ball can roll permanently, and the surface of the workpiece is protected.
At temperatures > 20°C, the carrying figure decreases linearly. (Example: at 90°C the load bearing capacity is max. 60%)

Material

Bearing
• plastic

Ball
• Ball-bearing steel, hardened

Screw
• Free cutting steel, blackened

More information

Notes
Special types on request.

Drawing

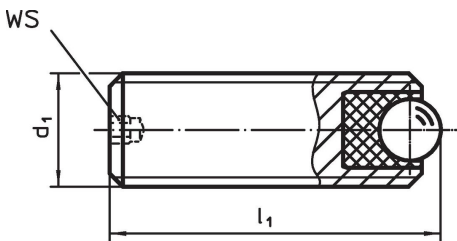

Order information

Dimensions			WS	Static carrying figure C ₀	Tightening torque max.	Temperature		Weight	Art. No.
d ₁	l ₁	Ball diameter				min.	max.		
[mm]			[mm]	[N]	[Nm]	[°C]		[g]	
Free cutting steel									
M16	20	8.5	3	1986	3.21	-50	90	20	22752.0161

Application example

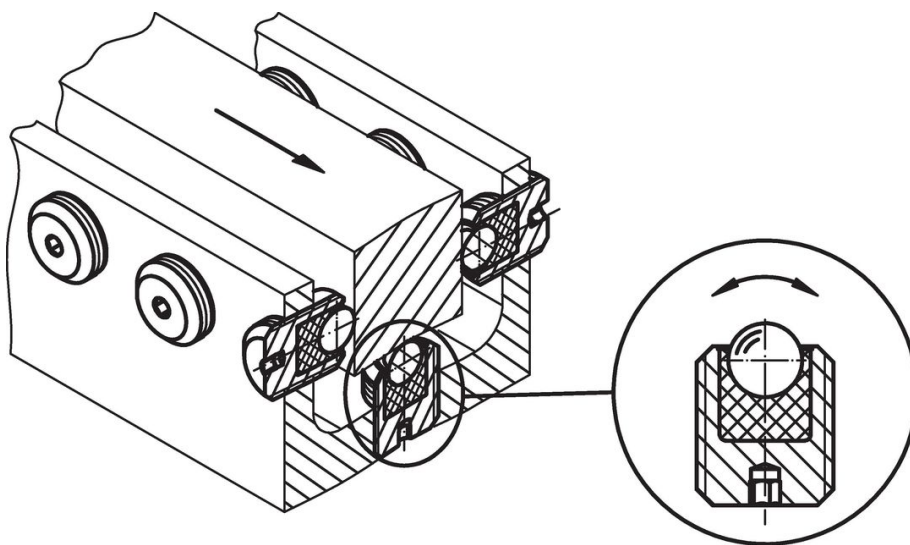

Compliance

RoHS compliant

Contains lead - compliant according to exceptions 6a / 6b / 6c.

Contains SVHC substances >0,1% w/w

Contains lead - SVHC list [REACH] as of 27.06.2024.

Contains Proposition 65 substances



Lead can cause cancer and reproductive harm from exposure
<https://www.P65Warnings.ca.gov/>

Free from Conflict Minerals

This product does not contain any substances designated as "conflict minerals" such as tantalum, tin, gold or tungsten from the Democratic Republic of Congo or adjacent countries.