

Ball Casters · with mounting elements

22750.0128



Product Description

Ball casters are module for transport systems, conveyances, to working and packing facilities. For example, parts can be easily moved, turned and controlled.

Material

Cap

- Steel, zinc-plated by galvanization

Housing

- Steel, zinc-plated by galvanization

Ball

- Stainless steel

Assembly

Mounting is carried-out by means of spring-loaded claws allowing big tolerances in the location hole.

The ball casters can easily be mounted and disassembled from their functional side.

Due to the inclined cap form, the assembly mandrel EH 22750. should be used.

Drawing

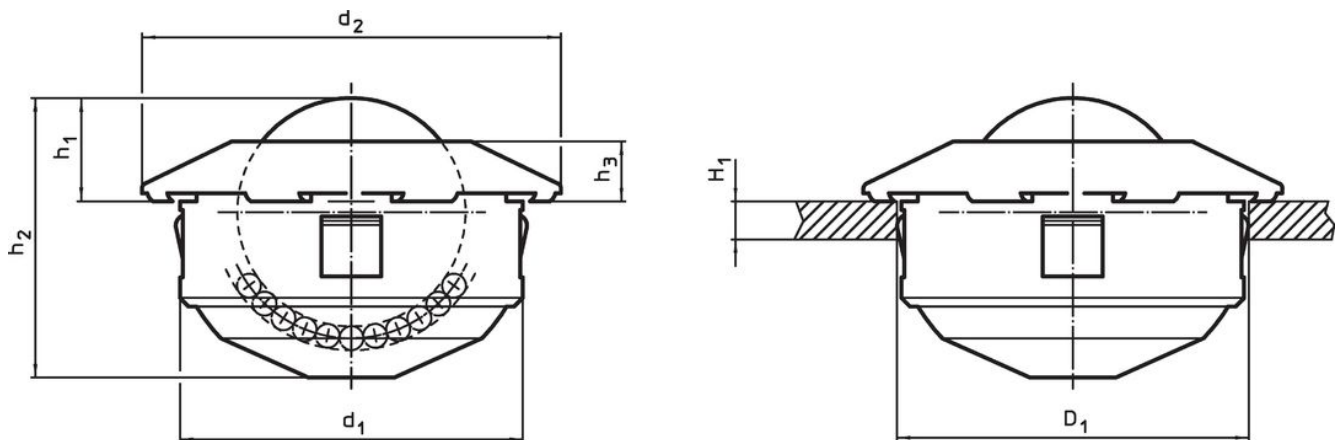

Order information

d ₁ -0.16	Ball diameter	Dimensions				H ₁ min. [mm]	Location hole D ₁ [mm]	Dynamic carrying figure C [N]	[g]	Art. No.
		d ₂ [mm]	h ₁ ±0.2	h ₂	h ₃					
ball from stainless steel										
36	22	45	9.8	28.6	6	2	36	970	143	22750.0128

Accessories

	Suitable for ball caster		[g]	Art. No.
	[mm]			
assembly tool				
	24		451	22750.0144
	36		480	22750.0148
	45		503	22750.0152

Application example

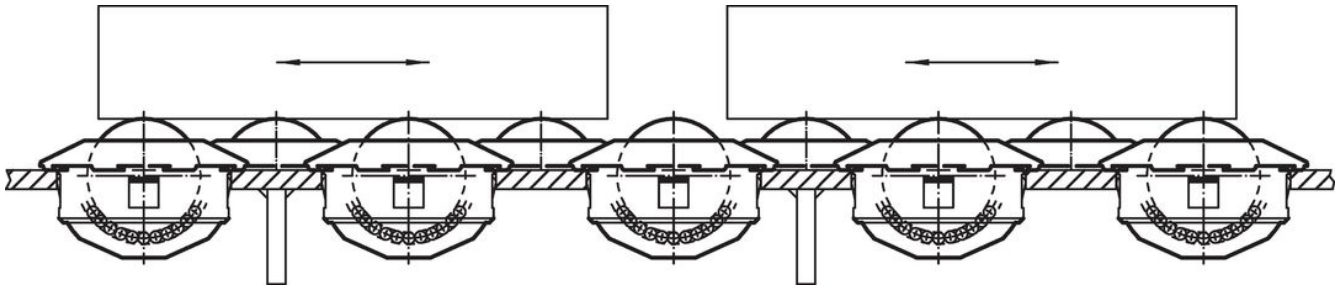

Compliance

RoHS compliant

Compliant according to Directive 2011/65/EU and Directive 2015/863.

Does not contain SVHC substances

No SVHC substances with more than 0.1% w/w contained - SVHC list [REACH] as of 23.01.2024.

Does not contain Proposition 65 substances

No Proposition 65 substances included.

<https://www.P65Warnings.ca.gov/>

Free from Conflict Minerals

This product does not contain any substances designated as "conflict minerals" such as tantalum, tin, gold or tungsten from the Democratic Republic of Congo or adjacent countries.