

## Ball Casters • with sheet steel housing

22750.0022



### Product Description

Ball casters are module for transport systems, conveyances, to working and packing facilities. For example, parts can be easily moved, turned and controlled. As from  $d_1 = 36$  fitted with an oil drenched felt seal to protect against dirt.

### Material

#### Cap

- Steel, zinc-plated by galvanization

#### Housing

- Steel, zinc-plated by galvanization

#### Ball

- Stainless steel

### More information

#### Further products

- Tolerance Rings

### Drawing

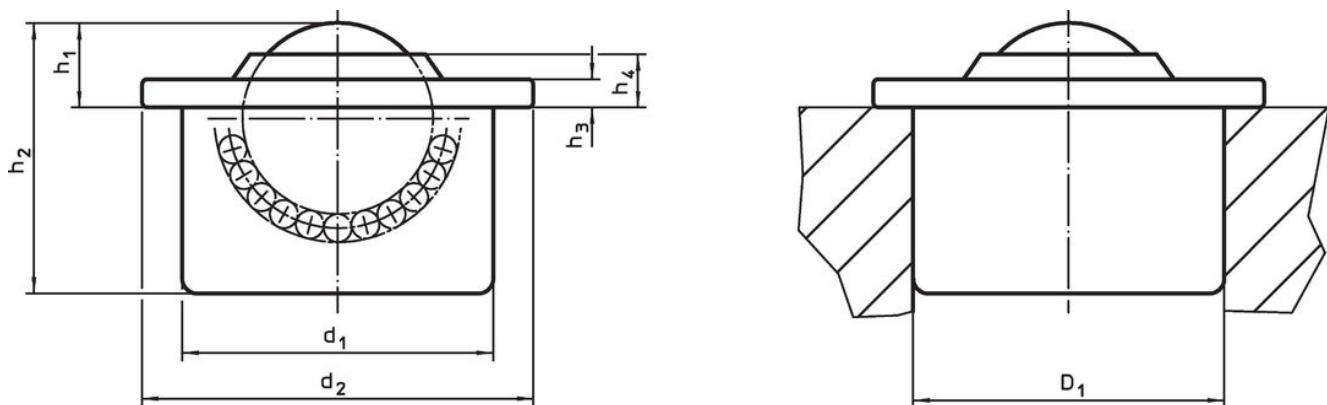

### Order information

$d_1$ $\pm 0.055$	Ball diameter	Dimensions				Location hole $D_1$ <sup>1)</sup> $+0.03$ [mm]	Dynamic carrying figure C [N]	[g]	Art. No. <sup>2)</sup>	
		$d_2$	$h_1$ $\pm 0.15$ [mm]	$h_2$	$h_3$					$h_4$
all parts zinc-plated, ball from stainless steel										
18	12	23	7.4	15.5	2	4.3	17.97	180	18	22750.0022

<sup>1)</sup> Reference value for 2 mm sheet steel/ 5 mm aluminium (force fit)

<sup>2)</sup> without felt seal

### Application example

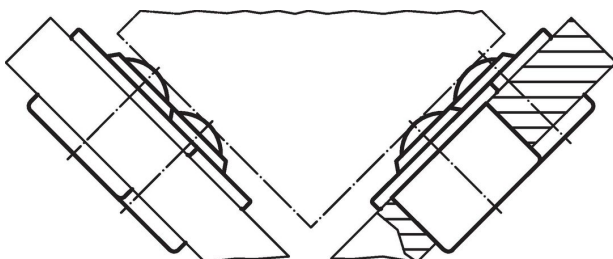



## Compliance

### RoHS compliant

Compliant according to Directive 2011/65/EU and Directive 2015/863.

### Does not contain SVHC substances

No SVHC substances with more than 0.1% w/w contained - SVHC list [REACH] as of 23.01.2024.

### Does not contain Proposition 65 substances

No Proposition 65 substances included.

<https://www.P65Warnings.ca.gov/>

### Free from Conflict Minerals

This product does not contain any substances designated as "conflict minerals" such as tantalum, tin, gold or tungsten from the Democratic Republic of Congo or adjacent countries.