

Self-Aligning Pads • self-resetting

22731.0428



Product Description

Self-aligning pads are used as stop, support and thrust pad and are suitable for installation in clamping elements.

By resetting to the parallel position the contact point of the self-aligning pad provides a defined initial position, thus preventing the pad clamping in an oblique position when inserting the workpiece.

Material

Spring element

- Thermoplastic PUR

Ball

- Ball-bearing steel, hardened, bright

Body

- Heat-treated steel, tempered, phosphated

More information

Notes

Ball protected against rotating.

Loading capacity valid for steel and stainless steel designs.

Drawing

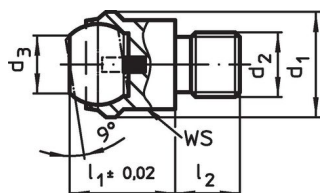

picture 1

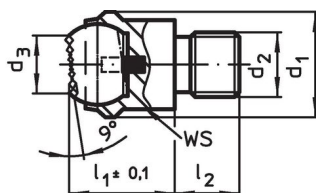

picture 2

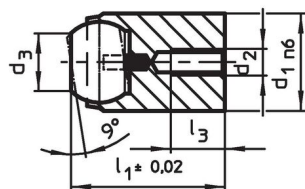

picture 3

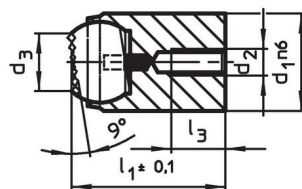

picture 4

Order information

d ₁ n6	d ₂	Dimensions			Ball diameter	Location hole		Load capacity for static load ¹⁾ max. [kN]	Tightening torque max. [Nm]	 [g]	Art. No.
		d ₃	l ₁	l ₃ max.		Ø H7	Depth min. [mm]				
28	M5	20	34	6	25	28	22	90	6	151	22731.0428

¹⁾ Applies only when the minimum bore depth is kept to.

Application example

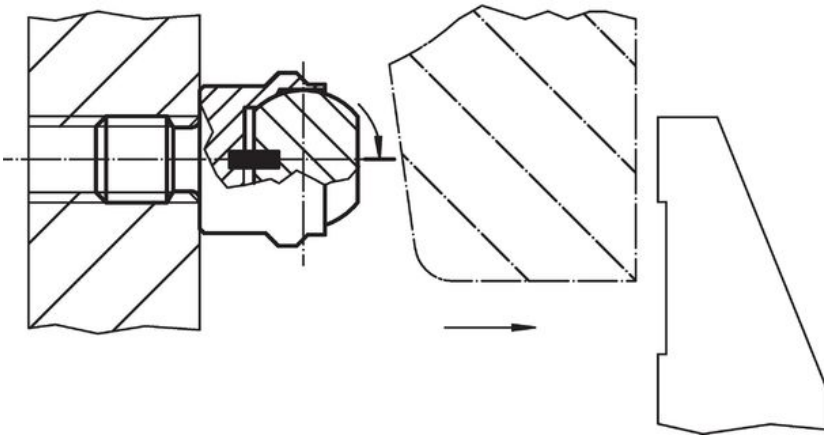
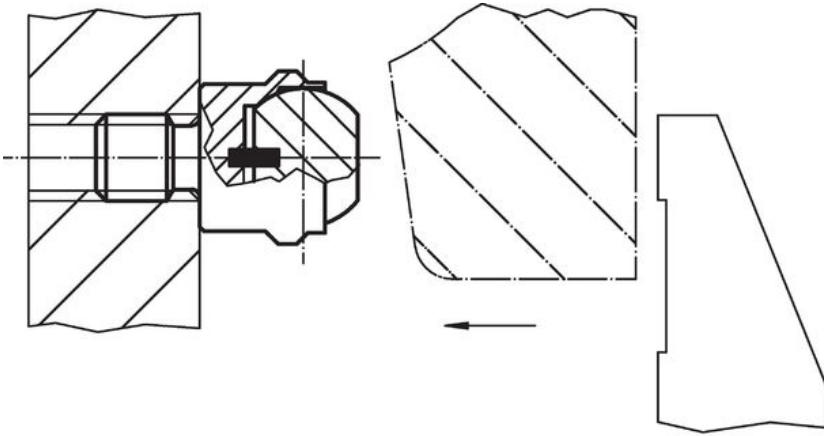

Compliance

RoHS compliant

Compliant according to Directive 2011/65/EU and Directive 2015/863.

Does not contain SVHC substances

No SVHC substances with more than 0.1% w/w contained - SVHC list [REACH] as of 23.01.2024.

Does not contain Proposition 65 substances

No Proposition 65 substances included.

<https://www.P65Warnings.ca.gov/>

Free from Conflict Minerals

This product does not contain any substances designated as "conflict minerals" such as tantalum, tin, gold or tungsten from the Democratic Republic of Congo or adjacent countries.