

Ball-Ended Thrust Screws • headless, with fine-pitch thread

22720.6264



Product Description

Ball-ended thrust screws can also be used for positioning and clamping, tightening or supporting of non-parallel surfaces.

The fine-pitch thread allows a precise adjustment.

The flat-faced, movable ball enables a flat load transmission.

Material

Ball

- Stainless steel, hardened

Screw

- Stainless steel 1.4305

More information

Notes

Ball not secured against rotating.
Special types on request.

References

Thread lock on request, please refer to appendix - Technical Data -

Further products

- Ball-Ended Thrust Screws, headless, ball protected against rotating
- Ball-Ended Thrust Screws, headless, round ball
- Ball-Ended Thrust Screws, headless, flat-faced ball

Drawing

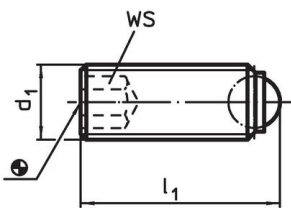

picture 1

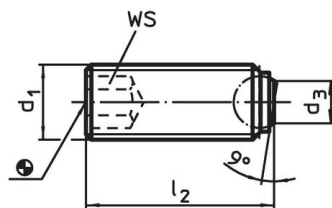

picture 2

Order information

d ₁	Dimensions			WS	Load capacity for static load ¹⁾ max. [kN]	max. [°C]	[g]	Art. No.
	l ₂	d ₃	Ball diameter					
[mm]								
flat-faced ball, bearing surface plain – picture 2, Stainless steel								
M6 x 0,5	25	3.2	4	3	9	250	4.4	22720.6264

¹⁾ Statements on load capacity are not valid for the stainless steel type.

Application example

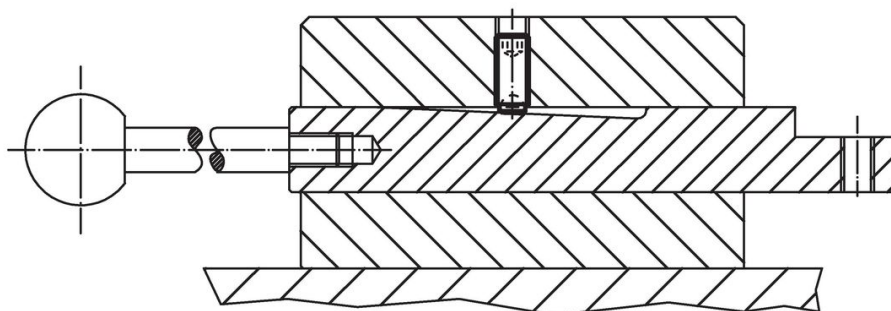

Compliance

RoHS compliant

Compliant according to Directive 2011/65/EU and Directive 2015/863.

Does not contain SVHC substances

No SVHC substances with more than 0.1% w/w contained - SVHC list [REACH] as of 23.01.2024.

Does not contain Proposition 65 substances

No Proposition 65 substances included.

<https://www.P65Warnings.ca.gov/>

Free from Conflict Minerals

This product does not contain any substances designated as "conflict minerals" such as tantalum, tin, gold or tungsten from the Democratic Republic of Congo or adjacent countries.