

Ball-Ended Thrust Screws • headed, ball protected against rotating

22700.0322



Product Description

Ball-ended thrust screws can also be used for clamping, tightening or supporting of non-parallel surfaces.
The flat-faced, movable ball enables a flat load transmission.

Material

Ball

- Stainless steel, hardened

Screw

- Stainless steel 1.4305

More information

Notes

Note: Thread runout l_4 !
Ball protected against rotating.
Special types on request.

References

Thread lock on request, please refer to appendix - Technical Data -

Further products

- Ball-Ended Thrust Screws, headed, flat-faced ball

Drawing

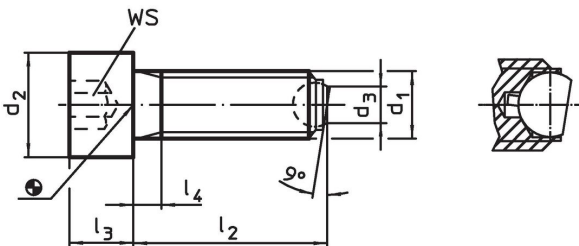

Order information

Dimensions							WS	Load capacity for static load ¹⁾ max.	Art. No.	
d_1	l_2	d_2	d_3	l_3	l_4	Ball diameter				
[mm]							[mm]	[kN]	[g]	
flat-faced ball, bearing surface plain, Stainless steel										
M10	25	16	6	10	4.5	7	8	12	24	22700.0322

¹⁾ Statements on load capacity are not valid for the stainless steel type.

Application example

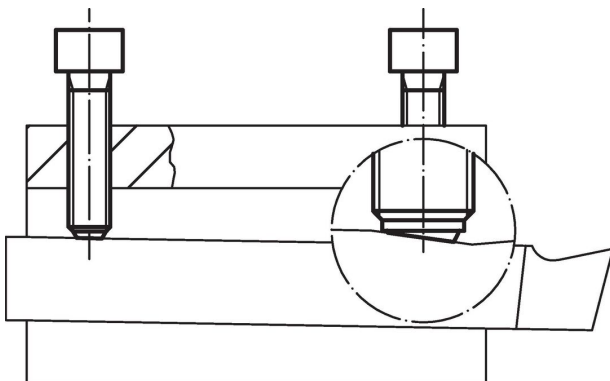

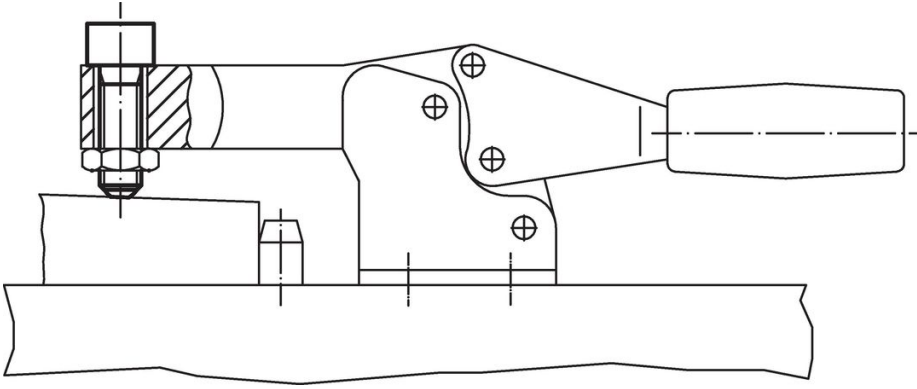

Compliance

RoHS compliant

Compliant according to Directive 2011/65/EU and Directive 2015/863.

Does not contain SVHC substances

No SVHC substances with more than 0.1% w/w contained - SVHC list [REACH] as of 23.01.2024.

Does not contain Proposition 65 substances

No Proposition 65 substances included.

<https://www.P65Warnings.ca.gov/>

Free from Conflict Minerals

This product does not contain any substances designated as "conflict minerals" such as tantalum, tin, gold or tungsten from the Democratic Republic of Congo or adjacent countries.