

Seating Pins • ribbed or pointed

22680.0101



Product Description

For workpieces showing a rough surface. Pointed type (picture 2) especially suitable for cast parts.

Material

Insert

- Hard metal, ribbed

Body

- Heat-treated steel, tempered, blackened

More information

Further products

- Pins

Drawing

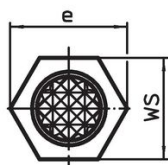
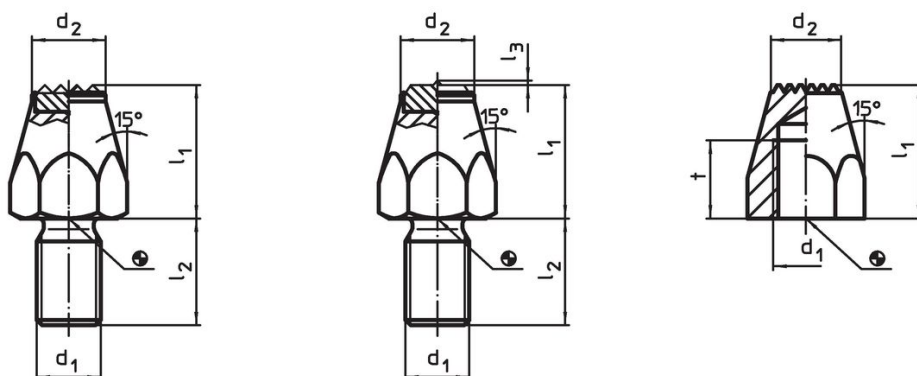

picture 1

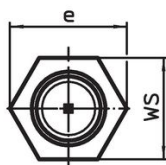

picture 2

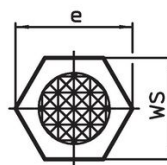

picture 3

Order information

l ₁	d ₁	Dimensions			e	WS [mm]	Tightening torque max. [Nm]	[g]	Art. No.
		l ₂	d ₂	[mm]					
with hard metal insert, ribbed, and threaded shank – picture 1									
20	M10	15	12.5	19.6	17	32	39	22680.0101	

Application example



Compliance

RoHS compliant

Compliant according to Directive 2011/65/EU and Directive 2015/863.

Does not contain SVHC substances

No SVHC substances with more than 0.1% w/w contained - SVHC list [REACH] as of 23.01.2024.

Does not contain Proposition 65 substances

No Proposition 65 substances included.

<https://www.P65Warnings.ca.gov/>

Free from Conflict Minerals

This product does not contain any substances designated as "conflict minerals" such as tantalum, tin, gold or tungsten from the Democratic Republic of Congo or adjacent countries.