

Feet • DIN 6320 with threaded shank
22640.0102



Product Description

Feet according to DIN 6320 can be used in fixture construction both as feet and as a seating element and stop.
The bearing surface has no centre.

Material

- Heat-treated steel, unhardened, blackened

Drawing

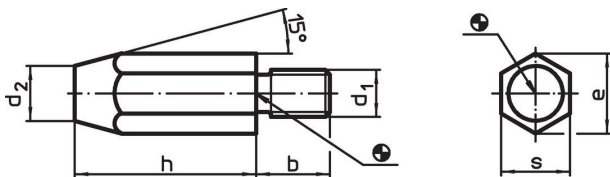

Order information

Dimensions							Tightening torque max. [Nm]	[g]	Art. No.
h	d ₁	b	d ₂	e	s				
40	M10	16	13	19.6	17	32	80	22640.0102	

Application example

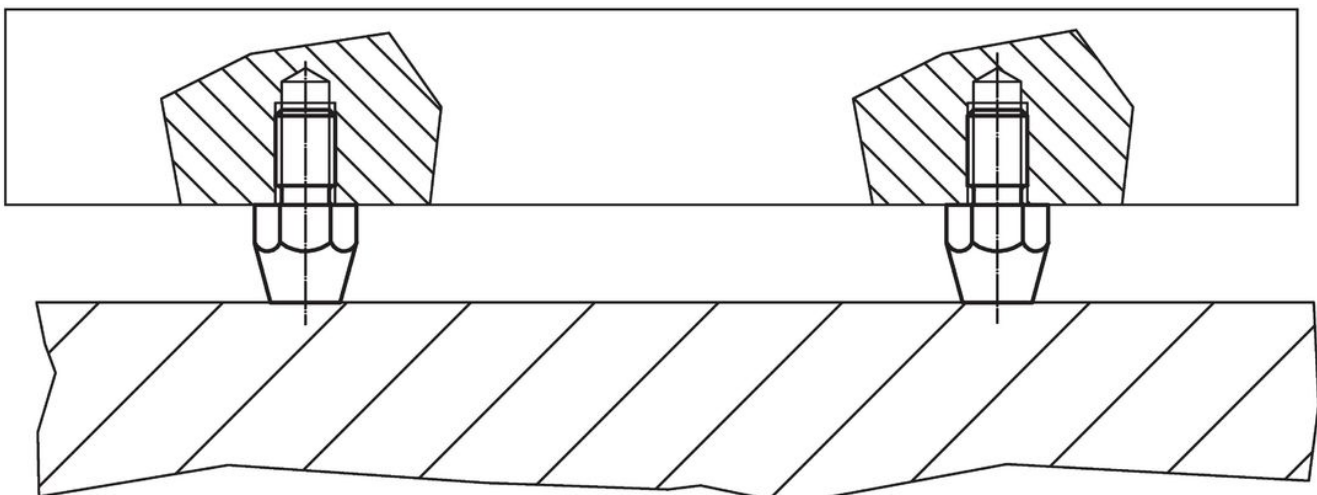

Compliance

RoHS compliant

Contains lead - compliant according to exceptions 6a / 6b / 6c.

Contains SVHC substances >0,1% w/w

Contains lead - SVHC list [REACH] as of 27.06.2024.

Contains Proposition 65 substances



Lead can cause cancer and reproductive harm from exposure

<https://www.P65Warnings.ca.gov/>

Free from Conflict Minerals

This product does not contain any substances designated as "conflict minerals" such as tantalum, tin, gold or tungsten from the Democratic Republic of Congo or adjacent countries.