

## Mounting Pads • protected against slipping

22590.1582



### Product Description

Mounting pads can be used as foot or thrust pad. Not parallel bearing surfaces up to 15° degrees can be compensated.  
The plastic cover on the mounting pad prevents slipping.

### Material

#### Ball element with bolt

- Stainless steel 1.4305

#### Rubber cap

- Rubber, black

#### Lock nut

- Stainless Steel A2, ISO 4032

#### Pad

- Thermoplastic POM, white

### More information

#### Notes

For the versions  $d_1 = M10$  and  $M12$  the lock nut conforms to DIN 934.

### Drawing

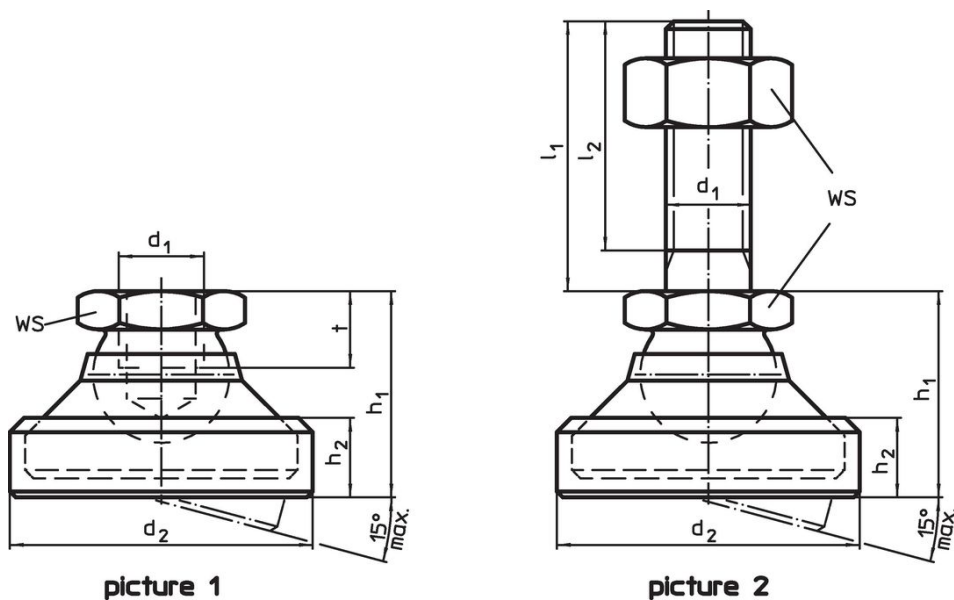

### Order information

$d_1$	$l_1$	$d_2$	Dimensions			WS	Load capacity for static load max.	[g]	Art. No.
			$l_2$	$h_1$	$h_2$				
			[mm]			[mm]	[kN]		
pad from thermoplastic, ball element with bolt from stainless steel – picture 2, Thermoplastic									
M20	100	67	92.5	49.5	19.5	30	22	573	22590.1582

## Compliance

### RoHS compliant

Compliant according to Directive 2011/65/EU and Directive 2015/863.

### Does not contain SVHC substances

No SVHC substances with more than 0.1% w/w contained - SVHC list [REACH] as of 23.01.2024.

### Does not contain Proposition 65 substances

No Proposition 65 substances included.

<https://www.P65Warnings.ca.gov/>

### Free from Conflict Minerals

This product does not contain any substances designated as "conflict minerals" such as tantalum, tin, gold or tungsten from the Democratic Republic of Congo or adjacent countries.