

Mounting Pads • protected against slipping

22590.1468



Product Description

Mounting pads can be used as foot or thrust pad. Not parallel bearing surfaces up to 15° degrees can be compensated.
The plastic cover on the mounting pad prevents slipping.

Material

Ball element with bolt

- Heat-treated steel, blackened

Rubber cap

- Rubber, black

Lock nut

- Steel, blackened, ISO 4032

Pad

- Heat-treated steel, tempered, blackened

More information

Notes

For the versions $d_1 = M10$ and $M12$ the lock nut conforms to DIN 934.

Drawing

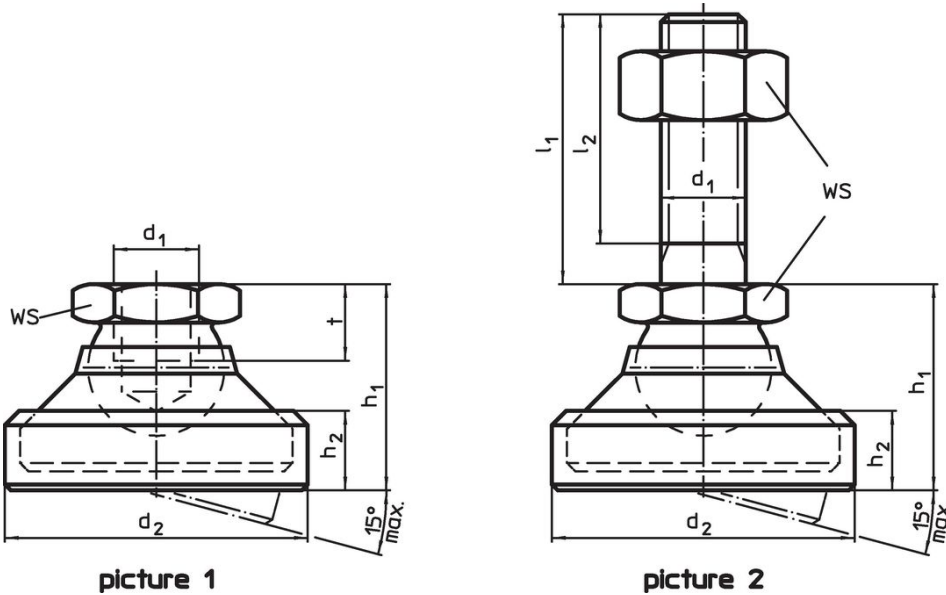

Order information

d_1	l_1	Dimensions				WS	Load capacity for static load max.	Art. No.
		d_2	l_2	h_1	h_2			
[mm]						[mm]	[kN]	[g]
pad and ball element with bolt from steel – picture 2, Heat-treated steel								
M16	100	56	94	37.5	15.5	24	45	440
								22590.1468

Compliance

RoHS compliant

Compliant according to Directive 2011/65/EU and Directive 2015/863.

Does not contain SVHC substances

No SVHC substances with more than 0.1% w/w contained - SVHC list [REACH] as of 27.06.2024.

Does not contain Proposition 65 substances

No Proposition 65 substances included.

<https://www.P65Warnings.ca.gov/>

Free from Conflict Minerals

This product does not contain any substances designated as "conflict minerals" such as tantalum, tin, gold or tungsten from the Democratic Republic of Congo or adjacent countries.