

Mounting Pads · with fastening holes

22590.0856



Product Description

Mounting pads can be used as foot or thrust pad. Not parallel bearing surfaces up to 15° degrees can be compensated.
Including two fastening holes in pad.

Material

Ball element with bolt

- Stainless steel 1.4305

Lock nut

- Stainless Steel A2, DIN 934

Pad

- Stainless steel 1.4305

More information

Notes

For the versions $d_1 = M10$ and $M12$ the lock nut conforms to DIN 934.

Drawing

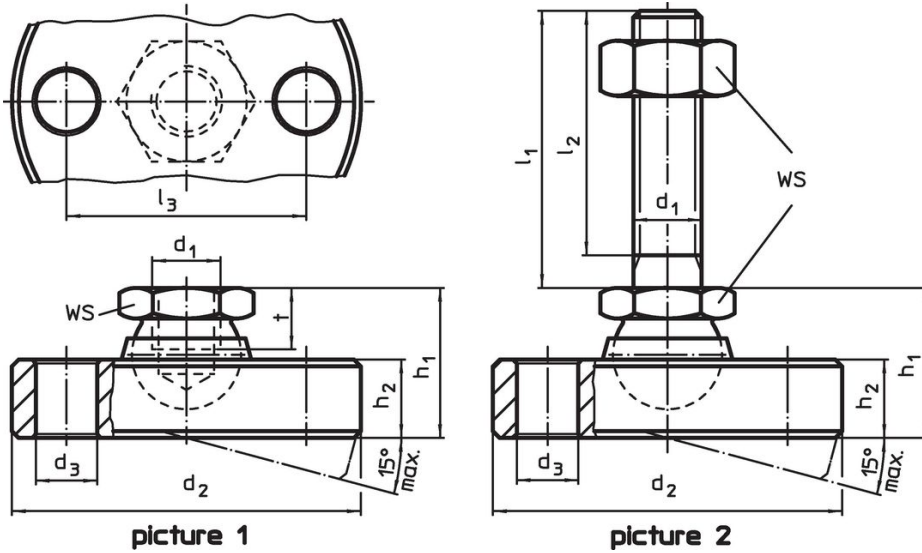

Order information

Dimensions								WS	Load capacity for static load max.		Art. No.
d_1	l_1	d_2 -0.5	d_3	l_2	l_3	h_1 ~	h_2				
[mm]								[mm]	[kN]	[g]	
pad and ball element with bolt from stainless steel – picture 2											
M12	150	65	9	144.5	48	26	12.5	19	28	510	22590.0856

Application example

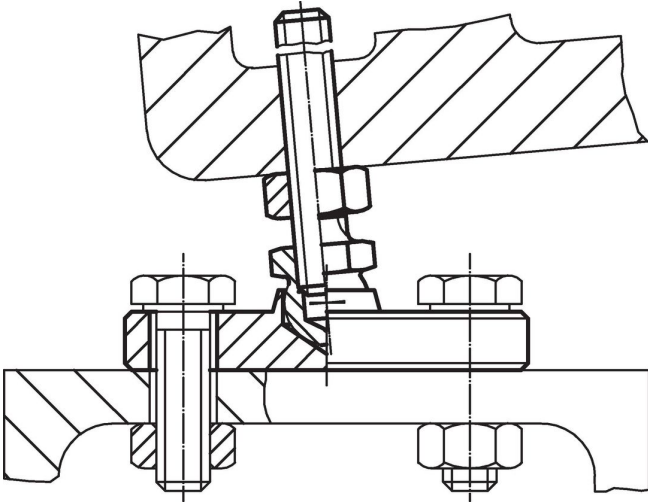

Compliance

RoHS compliant

Compliant according to Directive 2011/65/EU and Directive 2015/863.

Does not contain SVHC substances

No SVHC substances with more than 0.1% w/w contained - SVHC list [REACH] as of 23.01.2024.

Does not contain Proposition 65 substances

No Proposition 65 substances included.

<https://www.P65Warnings.ca.gov/>

Free from Conflict Minerals

This product does not contain any substances designated as "conflict minerals" such as tantalum, tin, gold or tungsten from the Democratic Republic of Congo or adjacent countries.