

Locating Bushings · with flange, for ball lock pins and socket pins

22400.0308



Product Description

Used for thin sheet materials, e.g. in vehicle construction, apparatus engineering, container construction and the aviation industry.
Locating bushings are used for quick and safe locating of ball lock pins EH 22340., EH 22350., EH 22370. and EH 22380. and socket pins EH 22400.
The bearing surface of the flange ensures optimum force distribution at components with thin walls.
All versions are corrosion and abrasion resistant.

Material

- Stainless steel 1.4305

Drawing

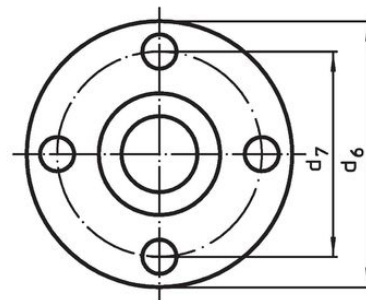
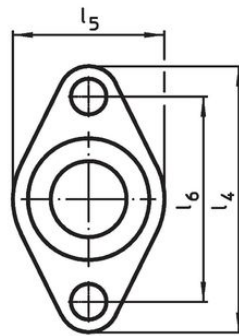
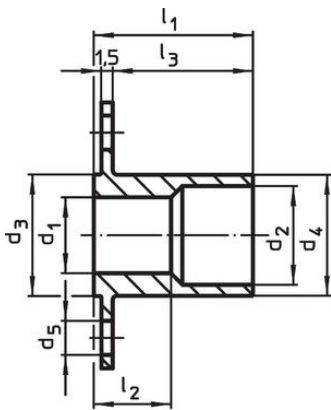

picture 1

picture 2

Order information

Dimensions											[g]	Art. No.	
d ₁	d ₂	d ₃	d ₄	d ₅	l ₁	l ₂	l ₃	l ₄	l ₅	l ₆			
H11		-0.05	-0.1										
with oval flange – picture 1													
8	10	12	11.9	4.5	19	10.3	16.5	30	18	22	9.8	22400.0308	

Application example

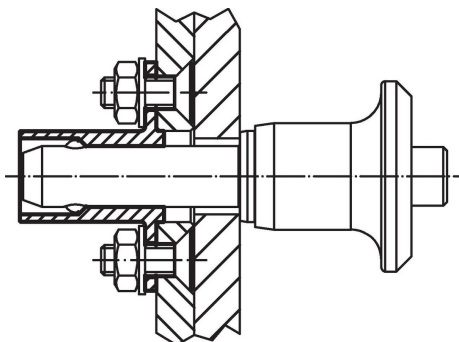

Compliance

RoHS compliant

Compliant according to Directive 2011/65/EU and Directive 2015/863.

Does not contain SVHC substances

No SVHC substances with more than 0.1% w/w contained - SVHC list [REACH] as of 27.06.2024.

Does not contain Proposition 65 substances

No Proposition 65 substances included.

<https://www.P65Warnings.ca.gov/>

Free from Conflict Minerals

This product does not contain any substances designated as "conflict minerals" such as tantalum, tin, gold or tungsten from the Democratic Republic of Congo or adjacent countries.