

## Retaining Cables • for threaded lock pin

22355.6012



### Product Description

These retaining cables are provided for attachment to the threaded lock pins EH 22355./EH22356 and act as loss prevention device.

#### Material

##### Holding clip

- Thermoplastic PA 6, black, dull similar to RAL 9005

##### Eyelet

- Stainless steel

##### Retaining cable

- Stainless steel

##### Coating retaining cable

- Thermoplastic PA 6 coated, black

#### More information

##### Notes

Special types on request.

##### Further products

- Retaining Cables

### Drawing

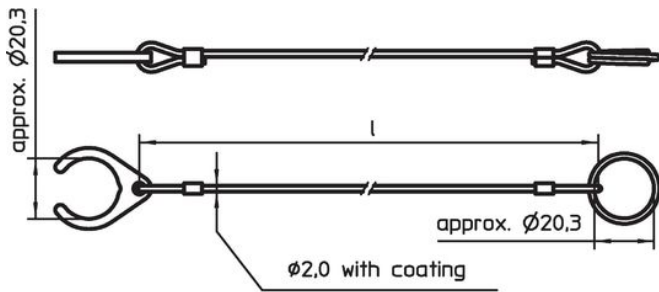

picture 1

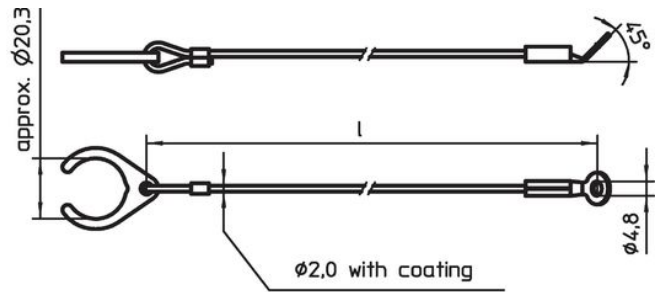

picture 2

### Order information

Dimensions		Art. No.
l	[g]	
[mm]		
stainless steel, with holding clip and eyelet – picture 2, Thermoplastic PA 6 coated, black		
200	10	22355.6012

## Application example

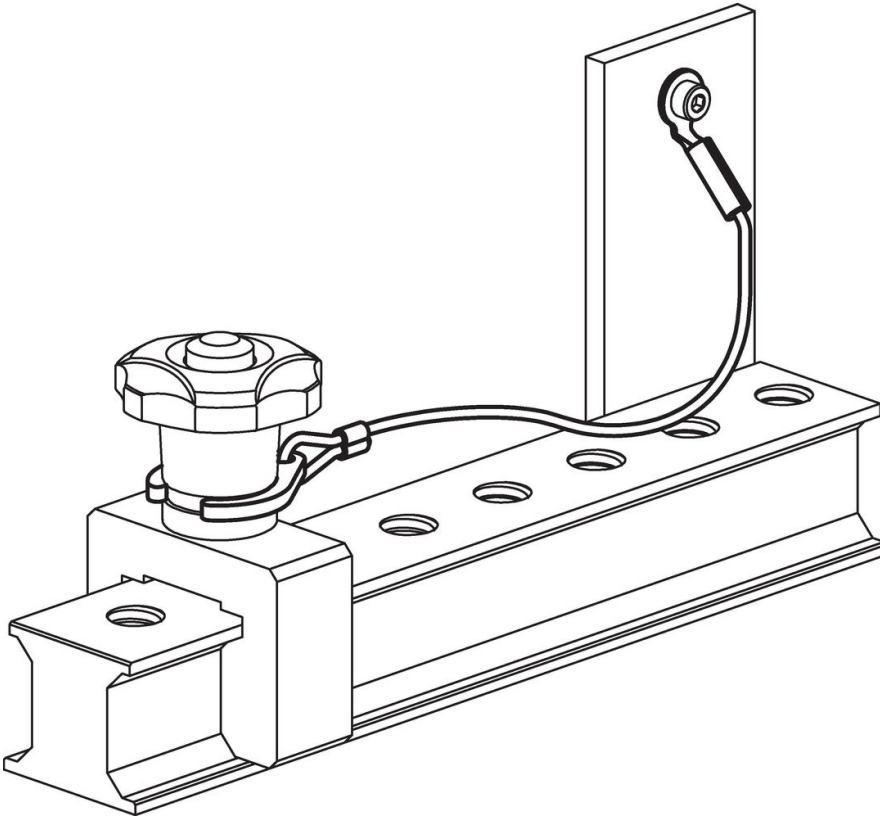

## Compliance

### RoHS compliant

Compliant according to Directive 2011/65/EU and Directive 2015/863.

### Does not contain SVHC substances

No SVHC substances with more than 0.1% w/w contained - SVHC list [REACH] as of 23.01.2024.

### Does not contain Proposition 65 substances

No Proposition 65 substances included.

<https://www.P65Warnings.ca.gov/>

### Free from Conflict Minerals

This product does not contain any substances designated as "conflict minerals" such as tantalum, tin, gold or tungsten from the Democratic Republic of Congo or adjacent countries.