

Retaining Cables • for threaded lock pin

22355.6001



Product Description

These retaining cables are provided for attachment to the threaded lock pins EH 22355./EH22356 and act as loss prevention device.

Material

Attaching ring

- Stainless Steel

Holding clip

- Thermoplastic PA 6, black, dull similar to RAL 9005

Retaining cable

- Stainless steel

Coating retaining cable

- Thermoplastic PA 6 coated, black

More information

Notes

Special types on request.

Further products

- Retaining Cables

Drawing

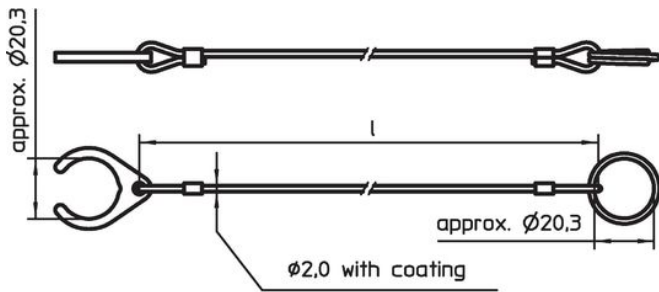

picture 1

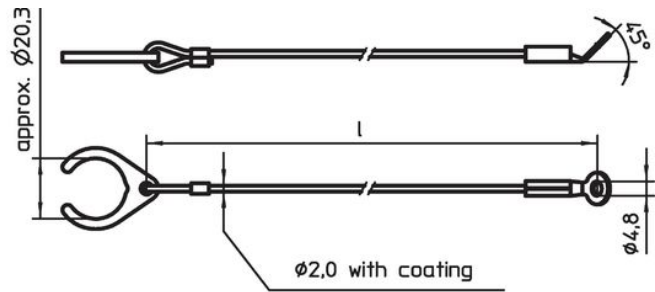

picture 2

Order information

Dimensions		Art. No.
l	[g]	
[mm]		
stainless steel, with holding clip and attaching ring – picture 1, Thermoplastic PA 6 coated, black		
150	13	22355.6001

Application example

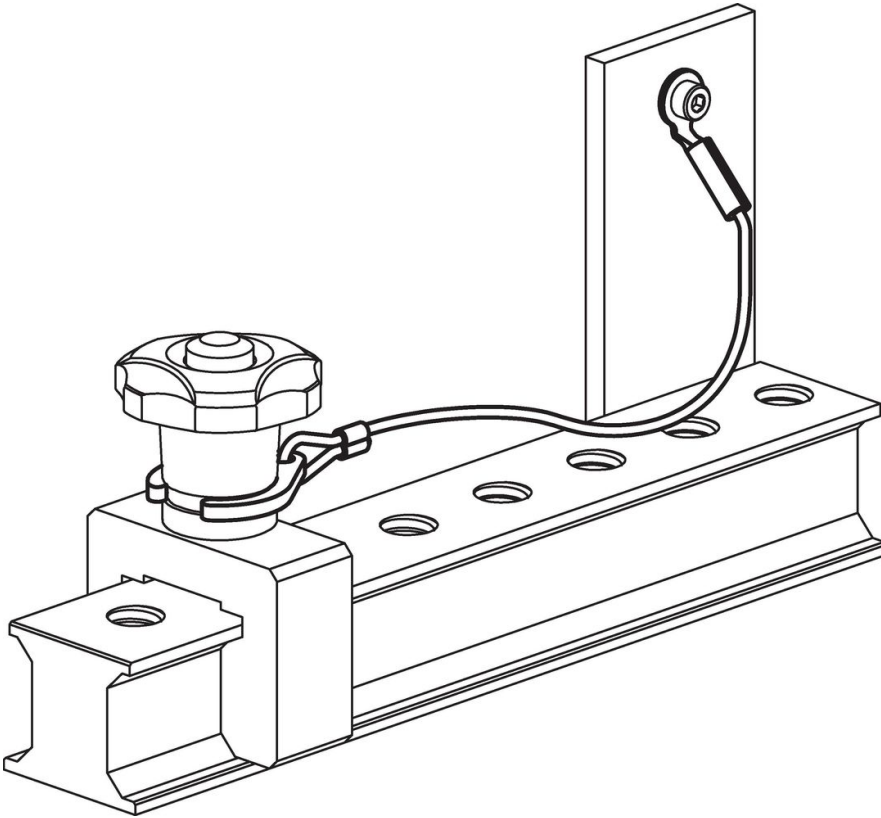

Compliance

RoHS compliant

Compliant according to Directive 2011/65/EU and Directive 2015/863.

Does not contain SVHC substances

No SVHC substances with more than 0.1% w/w contained - SVHC list [REACH] as of 23.01.2024.

Does not contain Proposition 65 substances

No Proposition 65 substances included.

<https://www.P65Warnings.ca.gov/>

Free from Conflict Minerals

This product does not contain any substances designated as "conflict minerals" such as tantalum, tin, gold or tungsten from the Democratic Republic of Congo or adjacent countries.