

Lifting Pins • self-locking

22350.0625



Product Description

Heavy-duty lifting element for quick and easy use, with moveable shackle and locking stud to provide protection against unintentional unlocking. Special lifting devices, e.g. threads for ring bolts, are no longer required on the workpiece. All versions are corrosion-resistant.

Material

Pin part

- Heat-treated steel, tempered, manganese phosphated

Press button

- Aluminium, red anodised

Shackle

- Heat-treated steel, tempered, manganese phosphated

Spring

- Stainless Steel

Assembly

Simple H11 boreholes are sufficient.

Mounting:

1. Press in the button and hold it down
2. Insert the lifting pin
3. Release the button (The button must be back in its original position)

Dismantling:

1. Press in the button and hold it down.
2. Remove the lifting pin.
3. Release the button.

Operation

Each lifting pin contains an instruction manual with an EC Declaration of Conformity.

More information

Accessories

As accessories, we offer matching locating bushings for $d_1 = 8, 10, 12, 16$ and 20

Further products

- Lifting Pins, self-locking, stainless steel
- Locating Bushings, for lifting pins
- Locating Bushings, plain, for lifting pins
- Locating Bushings with Seal, plain, for lifting pins
- Threaded Lifting Pins, self-locking
- Threaded Lifting Pins, self-locking, for centre holes according to DIN 332
- Threaded Lifting Pins, self-locking, with rotatable shackle
- Threaded Lifting Pins, self-locking - INCH
- Threaded Lifting Pins, self-locking, with rotatable shackle - INCH

Drawing



Order information

Dimensions													Load capacity according to DIN EN 13155			x		Location hole H11	max.		Art. No.
d_1	l_1	d_2	d_3	d_4	l_2	l_3	l_4	l_5	l_6	l_7	l_8	l_9	F_1	F_2	F_3	min.	max.	[mm]	[°C]	[g]	
-0.04	+0.6			min.	± 0.5								[kN]	[kN]	[kN]	[mm]		[mm]	[°C]	[g]	
10	35	11.7	21.5	12.2	10.2	25.7	36	27	30	49	87.5	21.5	2.7	2.4	2.1	1.5	10	10	250	299	22350.0625

Application example









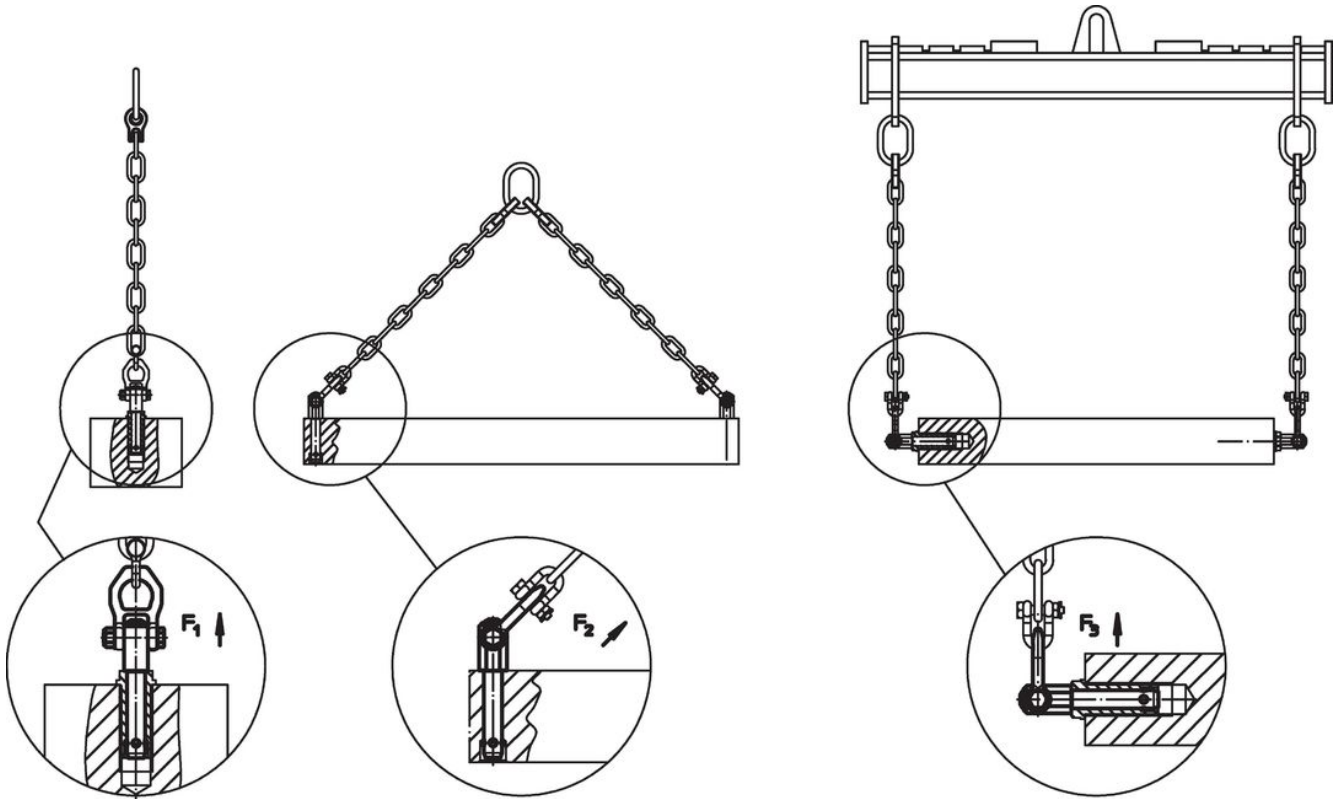

Compliance

Non-RoHS compliant

Not compliant according to Directive 2011/65/EU and Directive 2015/863.

Contains SVHC substances >0,1% w/w

Contains lead - SVHC list [REACH] as of 23.01.2024.

Contains Proposition 65 substances



Lead can cause cancer and reproductive harm from exposure
<https://www.P65Warnings.ca.gov/>

Free from Conflict Minerals

This product does not contain any substances designated as "conflict minerals" such as tantalum, tin, gold or tungsten from the Democratic Republic of Congo or adjacent countries.