

Clamping Catches

22260.0351



Product Description

Clamping catches have a round running taper surface and enable fast and safe clamping and releasing with a relatively large adjustment range and high tensioning force. Due to the small gradient angle of the taper surface, the clamping catch is self-locking.

Material

Body

- Stainless steel 1.4305, nickel-plated

Screw

- Stainless steel 1.4021, heat-treated, nickel-plated

Assembly

Fix with screw bolt M 10 (WS 6). Ensure a tightening torque of max. 40 Nm.

Operation

The screw bolt and the washer are adjustable. Once screwed in, the clamping catch can easily be turned to the desired position. For Art. No. 22260.0250 / .0251 and 22260.0450 / .0451, the serration helps to put the tension lever to the preferred position.

More information

Notes

Left turn type can be supplied on request.

Drawing

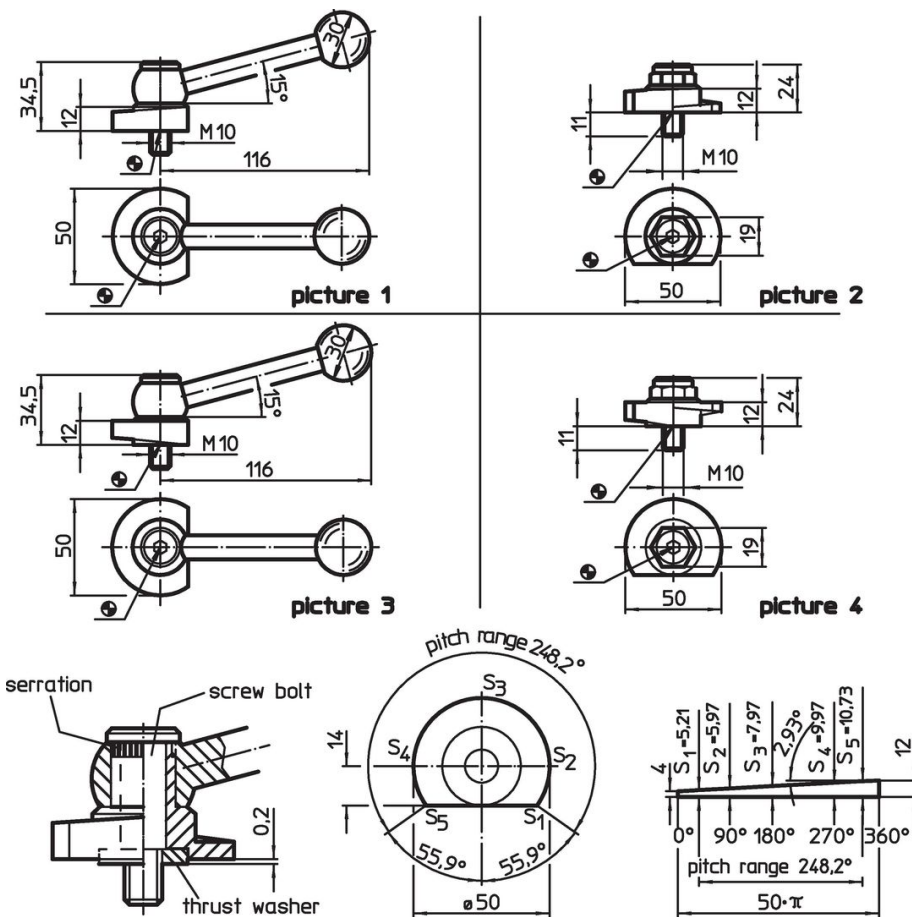

Order information

Tightening torque max. [Nm]	 [g]	Art. No.
40	with clamping screw, pitch opposite to bearing surface – picture 2, Stainless steel	22260.0351

Application example



Compliance

RoHS compliant

Compliant according to Directive 2011/65/EU and Directive 2015/863.

Does not contain SVHC substances

No SVHC substances with more than 0.1% w/w contained - SVHC list [REACH] as of 23.01.2024.

Does not contain Proposition 65 substances

No Proposition 65 substances included.

<https://www.P65Warnings.ca.gov/>

Free from Conflict Minerals

This product does not contain any substances designated as "conflict minerals" such as tantalum, tin, gold or tungsten from the Democratic Republic of Congo or adjacent countries.