

Clamping Catches

22260.0350



Product Description

Clamping catches have a round running taper surface and enable fast and safe clamping and releasing with a relatively large adjustment range and high tensioning force. Due to the small gradient angle of the taper surface, the clamping catch is self-locking.

Material

Body

- Steel, case-hardened, blackened

Screw

- Steel, nitrided

Assembly

Fix with screw bolt M 10 (WS 6). Ensure a tightening torque of max. 40 Nm.

Operation

The screw bolt and the washer are adjustable. Once screwed in, the clamping catch can easily be turned to the desired position. For Art. No. 22260.0250 / .0251 and 22260.0450 / .0451, the serration helps to put the tension lever to the preferred position.

More information

Notes

Left turn type can be supplied on request.

Drawing

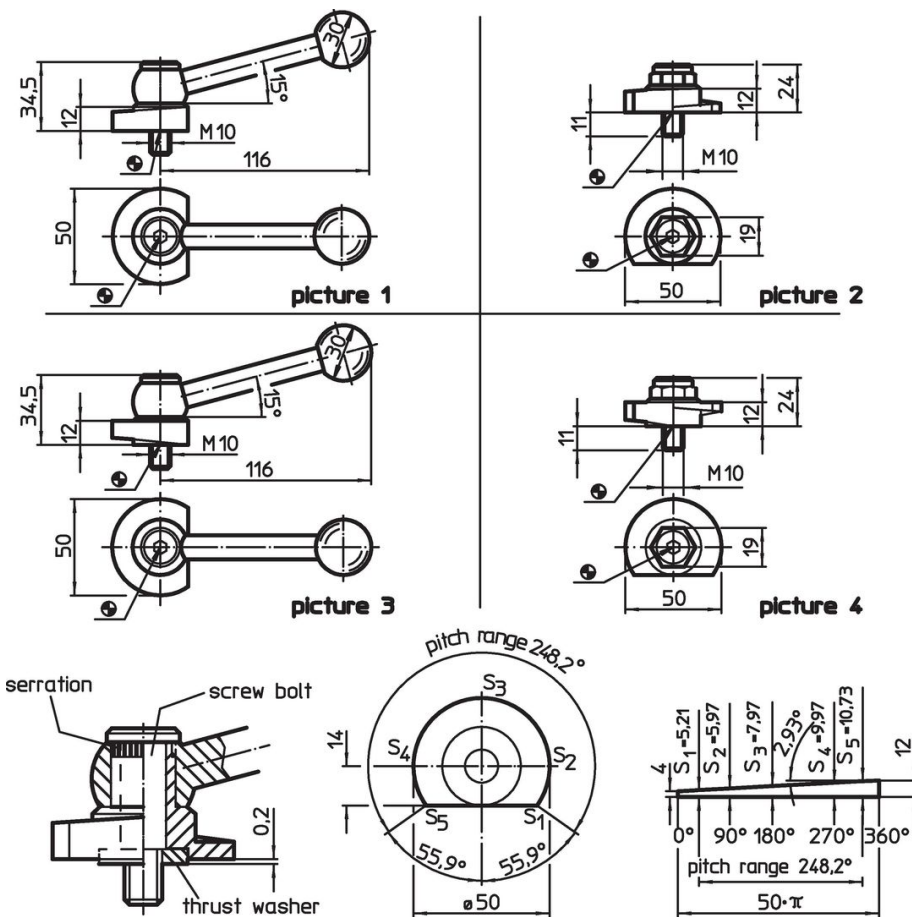

Order information

Tightening torque max. [Nm]	 [g]	Art. No.
40	154	22260.0350

Application example



Compliance

RoHS compliant

Contains lead - compliant according to exceptions 6a / 6b / 6c.

Contains SVHC substances >0,1% w/w

Contains lead - SVHC list [REACH] as of 23.01.2024.

Contains Proposition 65 substances



Lead can cause cancer and reproductive harm from exposure

<https://www.P65Warnings.ca.gov/>

Free from Conflict Minerals

This product does not contain any substances designated as "conflict minerals" such as tantalum, tin, gold or tungsten from the Democratic Republic of Congo or adjacent countries.