

Door Catches

22260.0016

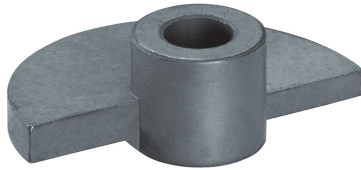

Product Description

Material

- Sintered steel

Assembly

Not suitable for fastening by welded connection. Secure by using pins.

Drawing

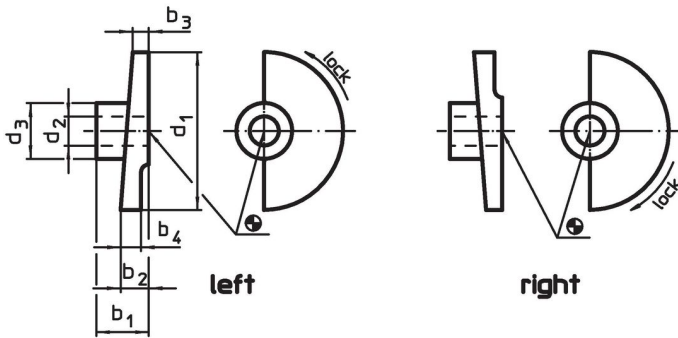

Order information

d ₁	d ₂ H8	d ₃	Dimensions				[g]	Art. No.
			b ₁	b ₂	b ₃	b ₄		
locking by turning to the right								
80	16	27	24	12	6	8.8	174	22260.0016

Application example

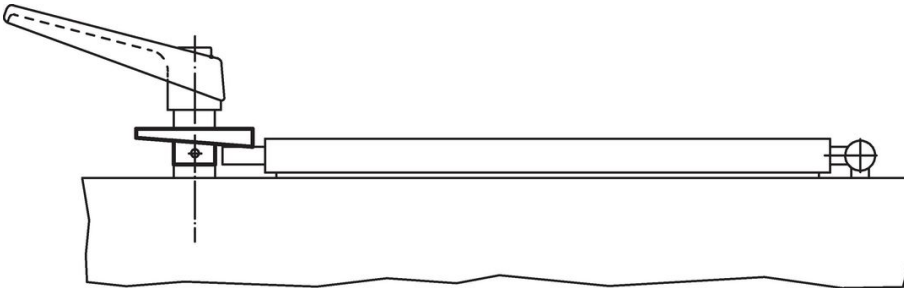

Compliance

RoHS compliant

Compliant according to Directive 2011/65/EU and Directive 2015/863.

Does not contain SVHC substances

No SVHC substances with more than 0.1% w/w contained - SVHC list [REACH] as of 23.01.2024.

Does not contain Proposition 65 substances

No Proposition 65 substances included.

<https://www.P65Warnings.ca.gov/>

Free from Conflict Minerals

This product does not contain any substances designated as "conflict minerals" such as tantalum, tin, gold or tungsten from the Democratic Republic of Congo or adjacent countries.