

## Precision Index Plungers · with tapered pin

22130.0112



### Product Description

Precision index plungers together with bushings are a perfect combination for quick positioning and mounting.

The precise tolerance of both, the precision index plunger and the bushing, guarantees a high repeatability of these two elements.

### Material

#### Pin

- Case-hardened steel, case-hardened, blackened and ground

#### Bushing

- Case-hardened steel, case-hardened, blackened and ground

#### Body

- Case-hardened steel, case-hardened, blackened and ground

#### Ball knob

- Thermoplastic, greyish black

### Assembly

For precise adjustment, the grip ball and plunger should be glued grease-free after assembly. Detailed assembly instructions can be downloaded as a PDF file under "Documents".

### Operation

When using locking index plungers the knob is pulled out and turned 90°.

### More information

### Notes

Bushings must be ordered separately.

### Drawing

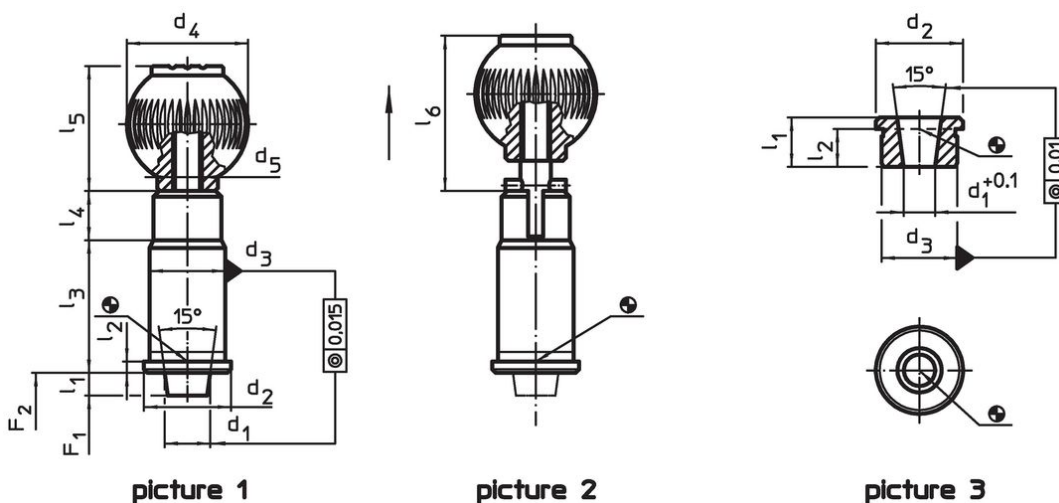

### Order information

Nominal diameter [mm]	d <sub>1</sub>	d <sub>2</sub>	d <sub>3</sub> n6	d <sub>4</sub>	Dimensions [mm]						Spring load <sup>1)</sup> F <sub>1</sub> ~ F <sub>2</sub> [N]		[g]	Art. No.
					d <sub>5</sub>	l <sub>1</sub> min.	l <sub>2</sub>	l <sub>3</sub>	l <sub>4</sub>	l <sub>5</sub>				
<b>without locking – picture 1</b>														
12	12	23	20	32	M8	6	3	35	13	33	22	35	135	22130.0112

<sup>1)</sup> statistical average value

### Accessories

Nominal diameter [mm]	d <sub>1</sub> +0.1	d <sub>2</sub>	d <sub>3</sub> n6	l <sub>1</sub> min.	l <sub>2</sub>	[g]	Art. No.	
								Dimensions [mm]
<b>Socket for precision index plungers, tapered – picture 3</b>								
	12	8.28	23	20	13	10.0	25	22130.0192

### Application example

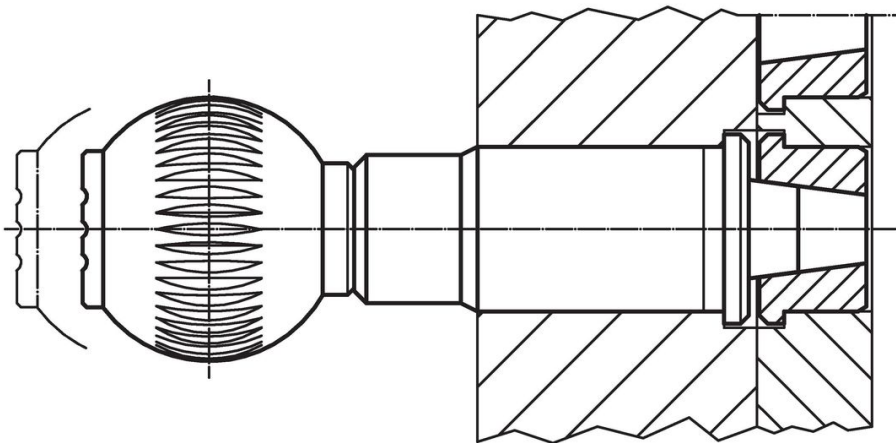

### Compliance

#### RoHS compliant

Contains lead - compliant according to exceptions 6a / 6b / 6c.

#### Contains SVHC substances >0,1% w/w

Contains lead - SVHC list [REACH] as of 23.01.2024.

#### Contains Proposition 65 substances



Lead can cause cancer and reproductive harm from exposure  
<https://www.P65Warnings.ca.gov/>

#### Free from Conflict Minerals

This product does not contain any substances designated as "conflict minerals" such as tantalum, tin, gold or tungsten from the Democratic Republic of Congo or adjacent countries.