

Index Plungers · with hexagon collar, stainless steel A4
22120.1075



Product Description

Index plungers are used for indexing bores.
The stainless steel A4 version ensures maximum corrosion resistance.

Material

Body

- Stainless steel 1.4401

Locking pin

- Stainless steel 1.4401 nickel-plated

Knob

- Stainless steel 1.4401

Lock nut

- Stainless steel 1.4401

More information

Notes

Knob not removable.
Lock nuts have to be purchased separately.

Drawing

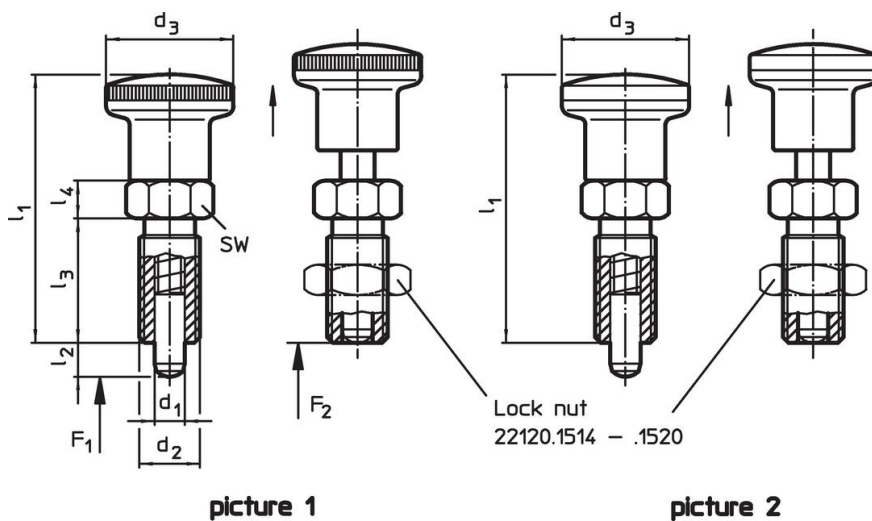

Order information

| Dimensions | | | | | | | Spring load ¹⁾ | | max. | | Art. No. |
|---|----------------|------------------------|----------------|----------------|----------------|----------------|---------------------------|---------------------|------|-----|------------|
| d ₁ | d ₂ | l ₂ min. | d ₃ | l ₁ | l ₃ | l ₄ | F ₁ ~ | F ₂ ~ | °C | g | |
| [mm] | | | | | | | [N] | | [°C] | [g] | |
| with knob from stainless steel – picture 2 | | | | | | | | | | | |
| 5 | M10 x 1 | 8 | 18 | 40 | 18 | 6 | 3 | 14 | 100 | 32 | 22120.1075 |

¹⁾ statistical average value

Accessories

| | Dimensions d ₂ [mm] | Wrench size [mm] | | Art. No. |
|---|--------------------------------------|---------------------|-----|------------|
| Lock nuts ISO 8675 (DIN 439), Stainless steel 1.4401 | | | | |
|  | M10 x 1 | 16 | 5.4 | 22120.1515 |

Compliance

RoHS compliant

Compliant according to Directive 2011/65/EU and Directive 2015/863.

Does not contain SVHC substances

No SVHC substances with more than 0.1% w/w contained - SVHC list [REACH] as of 23.01.2024.

Does not contain Proposition 65 substances

No Proposition 65 substances included.

<https://www.P65Warnings.ca.gov/>

Free from Conflict Minerals