

## Index Bolts • with mounting flange, horizontal

22120.1036



### Product Description

Index bolts are used for indexing purposes.

#### Material

##### Housing

- Zinc die-cast, plastic coated, black

##### Locking pin

- Steel, zinc-plated by galvanization

##### Catch

- plastic

#### Assembly

Assembly by means of washers ISO 7092.

#### Operation

When using the model with locking mechanism, you pull out the bolt, turn it by 70° and secure it using the notched catch (if the locking pin should not overhang).

### Drawing

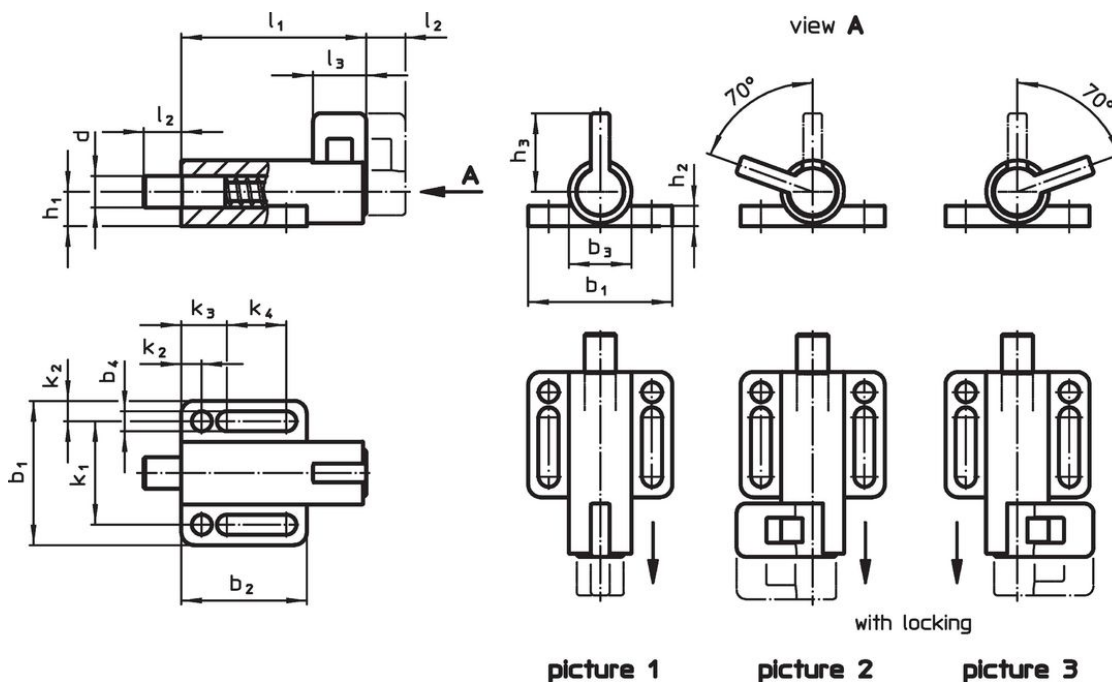

### Order information

Dimensions														Spring load <sup>1)</sup>		Temperature		Weight [g]	Art. No.	
d	l <sub>2</sub>	b <sub>1</sub>	b <sub>2</sub>	b <sub>3</sub>	b <sub>4</sub>	h <sub>1</sub>	h <sub>2</sub>	h <sub>3</sub>	k <sub>1</sub>	k <sub>2</sub>	k <sub>3</sub>	k <sub>4</sub>	l <sub>1</sub>	l <sub>3</sub>	F <sub>1</sub>	F <sub>2</sub>	min.			max.
-0.05	min.														~	~				
[mm]														[N]		[°C]		[g]		
<b>without locking – picture 1</b>																				
12	12	46	40	20	6.4	11	6	29	33	6.5	14.5	19	71	17	25	38	-30	80	137	22120.1036

<sup>1)</sup> statistical average value

### Application example



### Compliance

#### RoHS compliant

Contains lead - compliant according to exceptions 6a / 6b / 6c.

#### Contains SVHC substances >0,1% w/w

Contains lead - SVHC list [REACH] as of 23.01.2024.

#### Contains Proposition 65 substances



Lead can cause cancer and reproductive harm from exposure  
<https://www.P65Warnings.ca.gov/>

#### Free from Conflict Minerals

This product does not contain any substances designated as "conflict minerals" such as tantalum, tin, gold or tungsten from the Democratic Republic of Congo or adjacent countries.